

Radiance massage chair arrives in one box.
Le fauteuil de massage Radiance est livré dans une seule boîte.



- 1 Open the box and remove all contents.** Remove the packing materials. Take the base & footrest out of the box. Collect all the accessories and put them aside.
Ouvrez la boîte et retirez son contenu. Enlevez les matériaux d'emballage. Retirez la base du fauteuil et le repose-pieds de la boîte et ensuite ramassez tous les accessoires et mettez-les de côté.



- 2 Adjust chair position.** Use the power cord to connect the chair to the power supply and turn on the power switch. The chair will go back to home position. Then disconnect the power cord..
Ajustez la position du fauteuil. Utilisez le cordon d'alimentation pour connecter le fauteuil à une source d'alimentation et ensuite activez l'interrupteur. Le fauteuil s'ajuste à sa position par défaut. Débranchez ensuite le cordon d'alimentation.





- 3 Remove footrest fixing plates from chair base.** Locate the fixing plates on the chair base. Slacken and remove the screws, then take off the footrest fixing plate. Put the screws and footrest fixing plate aside the chair base.
Enlevez les plaques de fixation du repose-pieds de la base du fauteuil. Situez les plaques de fixation sur la base du fauteuil. Desserrez et retirez les vis, ensuite retirez la plaque de fixation du repose-pieds. Mettez les vis et la plaque de fixation du repose-pieds de côté dans la base du fauteuil.



- 4 Connect the wire and air hose in footrest.** Plug the footrest wire connectors tightly. Then connect the air hose.
Caution: Connect the same color air hose together.
Raccordez le fil et le tube d'air dans le repose-pieds. Branchez fermement les connecteurs de fils du repose-pieds. Connectez ensuite le tuyau d'air.
Attention: Raccordez les tuyaux d'air de même couleur entre eux.



- 5 Attach footrest to chair base.** Attach the footrest onto the brackets of the chair base. Then fix the footrest fixing plates to secure the footrest.
Attachez le repose-pieds à la base du fauteuil. Installez le repose-pieds sur les pattes de fixation du socle du fauteuil. Fixez ensuite les plaques de fixation du repose-pieds pour sécuriser le repose-pieds.



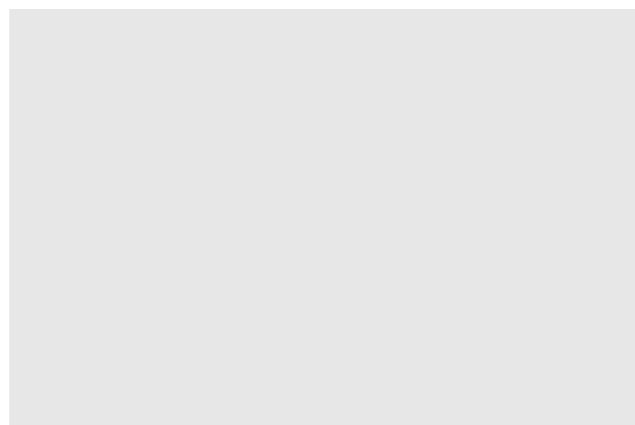

- 6** Zip the zipper between seat pad and footrest cushion.
Fermez la fermeture éclair entre le coussin de siège et le coussin du repose-pieds.

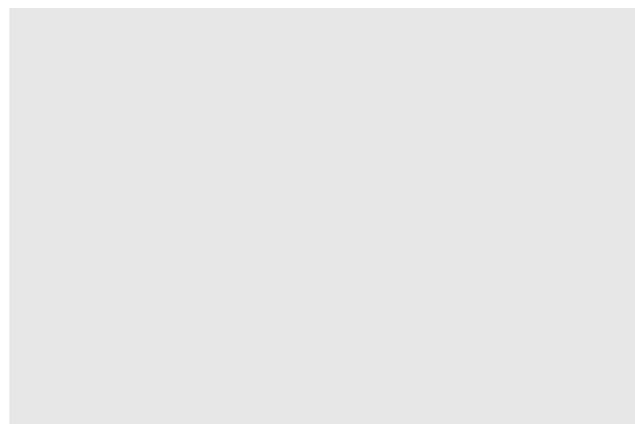

- 7** **Turn on the chair.** Connect the chair to the power supply and turn on the power switch. The chair will now be ready to start.
Activer le fauteuil. Raccordez le fauteuil par l'alimentation électrique et activez l'interrupteur. Le fauteuil sera maintenant prêt à utiliser.

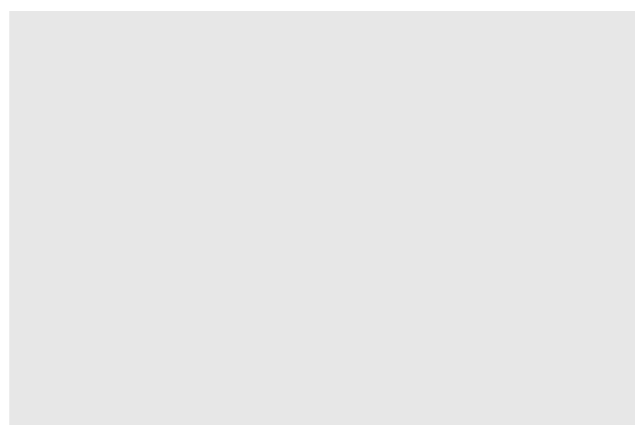

Radiance



User Manual

| CZ-330

Hello.

Congratulations on purchasing your new Cozzia Radiance.

At Cozzia we understand that every body is different and have carefully designed your massage chair with that in mind. But enough about us, this is about you. Learning how to use your new chair is simple (we designed it that way).

So let's get started.

Need a deeper massage? Remove Softening Pad

- 1** *Unzip*
- 2** *Fold Down*
- 3** *Remove Pad*

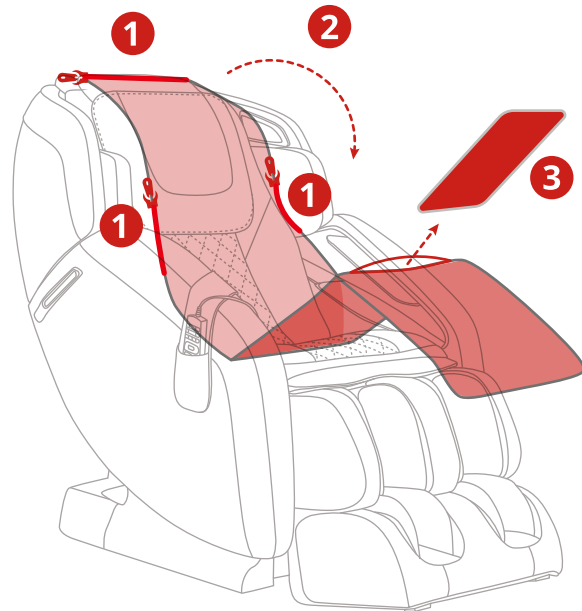

TABLE OF CONTENTS



INTRO

Dimensions	3
Contents	4



CHAIR

Move & Clearance	5
Components	6
Massage Points	7
Specifications	8
How To Use	9-12



CARE

Safety	13-15
Grounding Instructions	16
Troubleshooting	16
Care and Storage	17
Warranty	17-18

DIMENSIONS

First, let's get your chair inside.

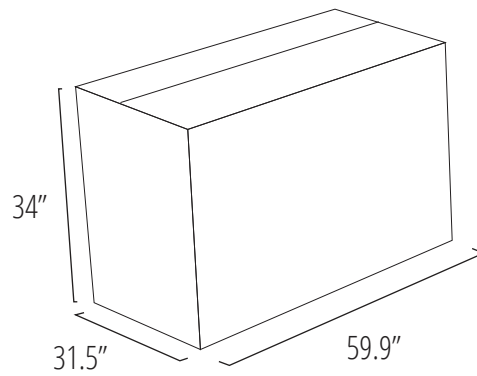
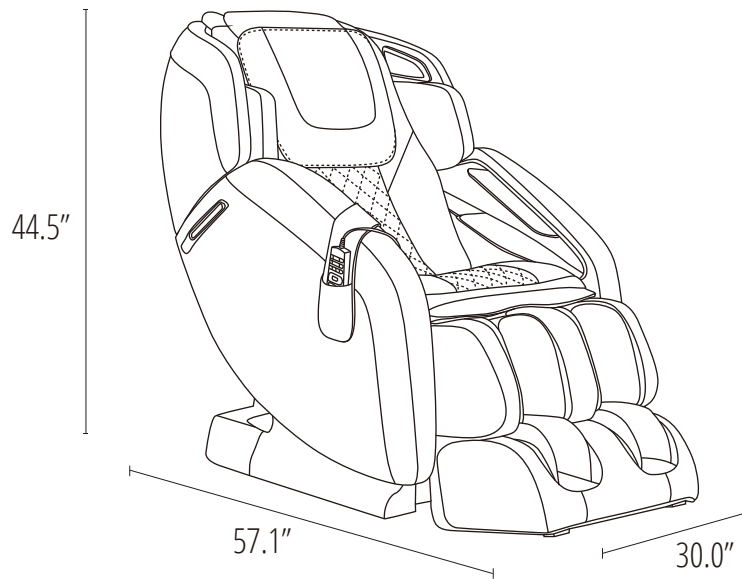

Master Carton

CONTENTS

Everything you need for a relaxing experience.



User Manual

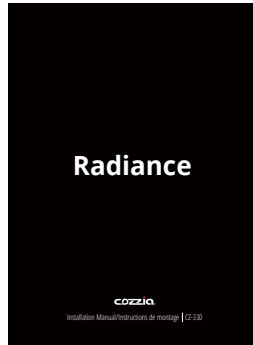

Installation Manual



Warranty Postcard

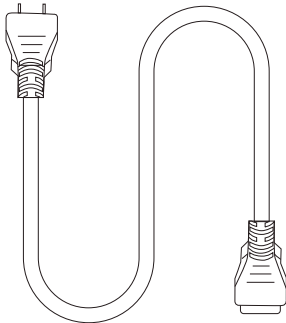

Power Cord



Wried LCD Remote



Radiance Massage Chair

MOVE & CLEARANCE

A few simple steps to find the best place for your new chair.

HOW TO MOVE

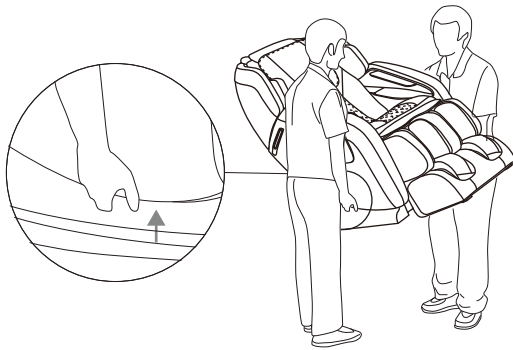

Lift and hold the bottom of the chair

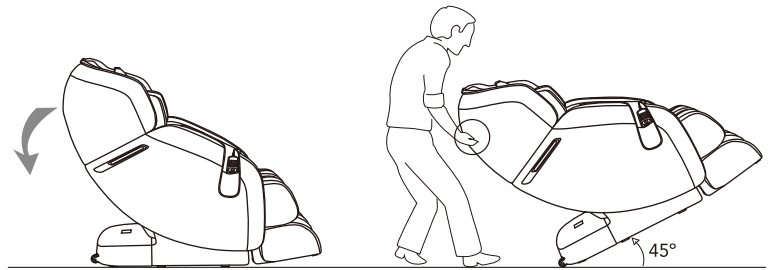

Lower down the backrest 45 degrees onto wheels

CLEARANCE

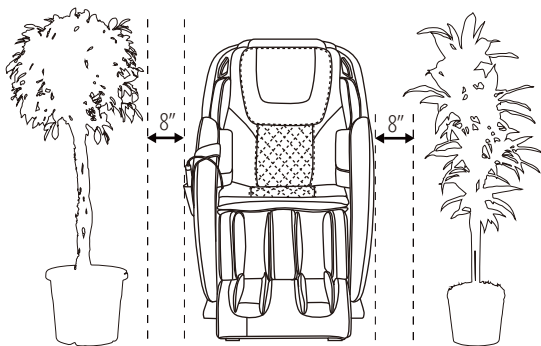

Reserve space on left and right

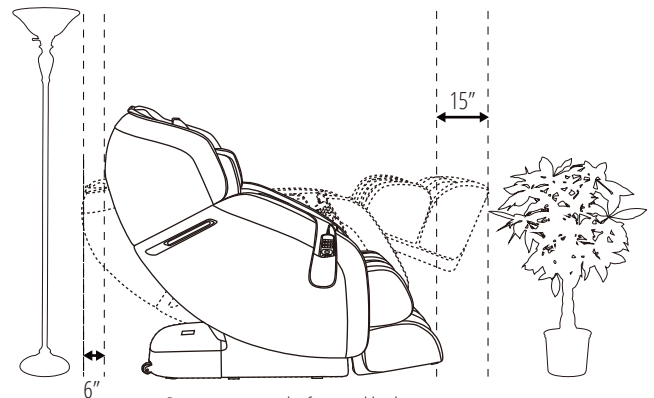

Reserve space on the front and back

CHAIR COMPONENTS

Some of your chair's most important features.

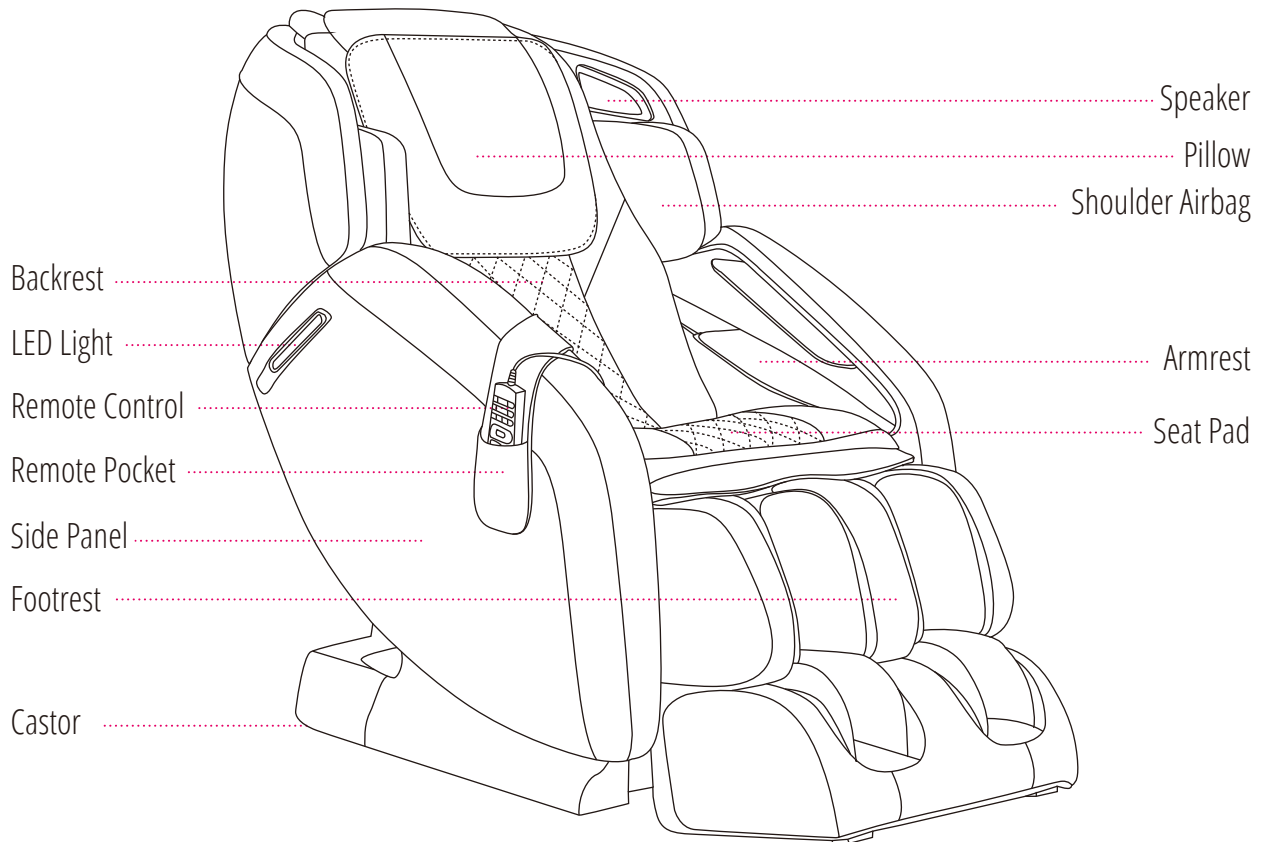

Note: The speaker will only operate when the massage chair is in operation



To play music using your massage chair's speakers please connect your smartphone, tablet, or other electronic device to your chair using bluetooth.

MASSAGE POINTS

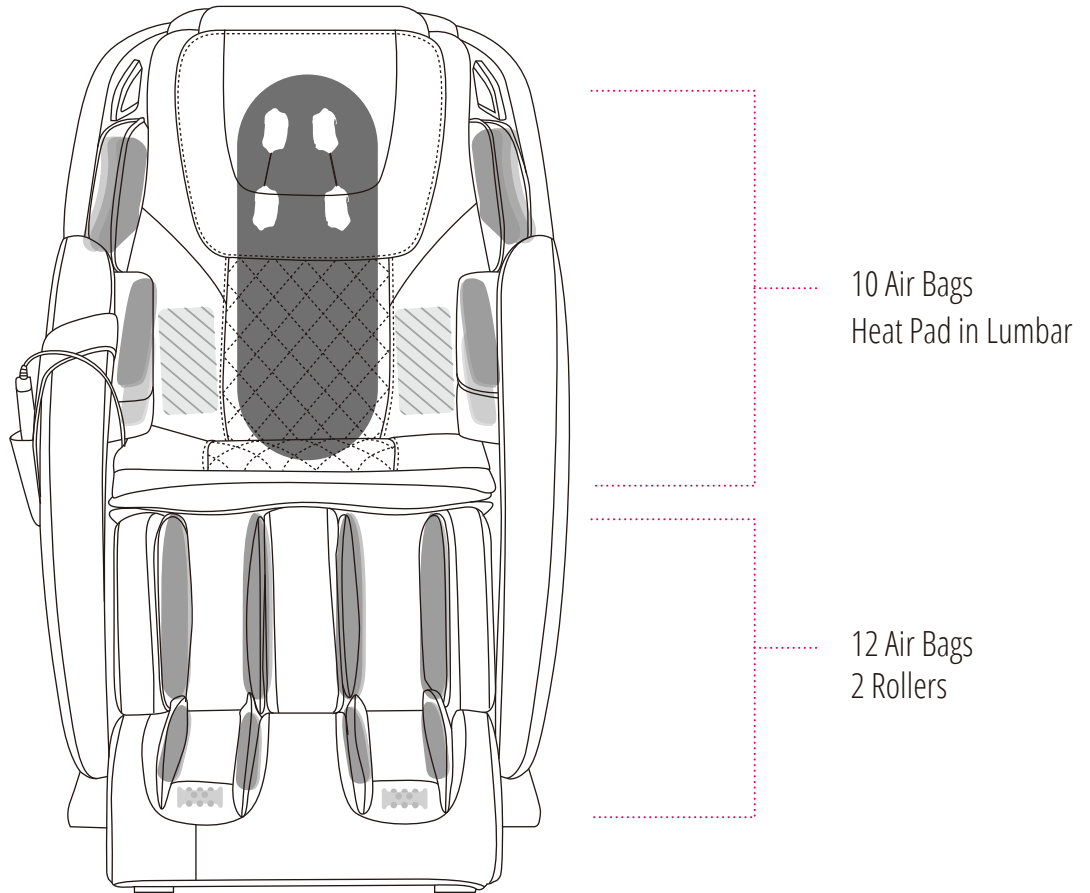

●
Back Massage Mode

●
Air Bag

■
Roller

■
Heater

CHAIR SPECIFICATIONS

A few important facts about your massage chair.



Model No.

Radiance



Massage Time

5 to 30 Minutes

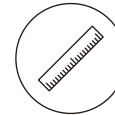

Dimensions (L x W x H)

Chair Dimensions: 57.1" x 30.0" x 44.5"
Reclined Dimensions: 68.5" x 30.0" x 32.6"



Shipping Weight

Gross Weight: 198 lbs
Net Weight: 171 lbs

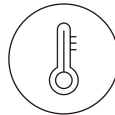

Usage Condition

Environment Temperature: 10°C-40°C
Contrasting Humidity: 30-85RH

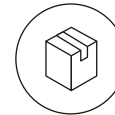

Storage Condition

Storage Temperature: -20°C-60°C
Storage Humidity Level: 30-85RH



Rated Current

1.2A



Rated Voltage

110 - 120V



Rated Frequency

60Hz



Power of Speakers

12W (2 sides)



Length of Wiring

Controller Wiring: 43.3"
Power Supply Wiring: 78.7"



Safety Feature

Equipped With Overheating
and Power Surge Detectors

HOW TO USE

Connect the chair to a power supply, then turn switch to the "I" position. The chair is now in idle mode.

During idle mode, the on/off button is off.

During idle mode, only the on/off, pause, ZG and chair recline/restore buttons can be operated.

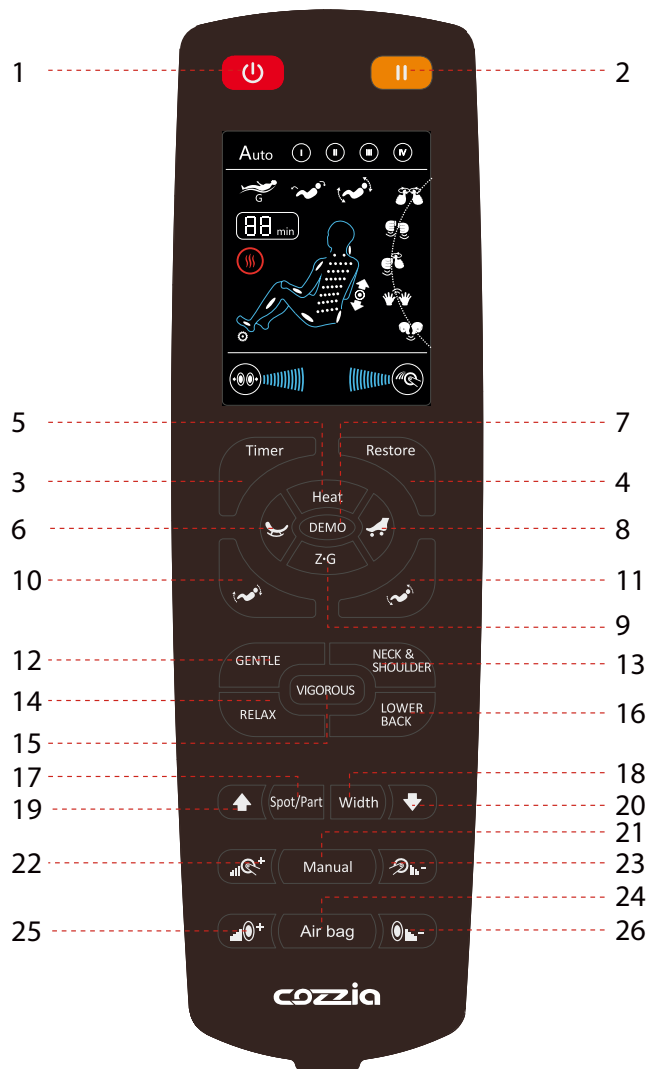

1. ON/OFF

The Start/Stop Control Button

Press this button to light up the LCD screen. Press any massage function button to start massage. This will initiate the timer function. Press this button again to stop all massage functions, massage chair will return to its original position.

2. PAUSE

Press this button once to halt current massage function and count down timer. During pause mode, the pause button will be blinking. Press this button again to cease the "Pause" function and resume previous massage function as well as countdown timer.

3. TIMER

Time Interval Control Button

When a massage function is activated, the timer is preset at 15 minutes. Every single press on this button will change the timer interval in the sequence of "20>25>30>5>10>15>20" minutes.

4. RESTORE

Press this button to make the chair restore to its original position.

5. HEAT

Lumbar Heat Function Start/Stop Control Button

Press this button to activate lumbar heat function, press this button again to stop the heat function.
Note: During Auto Program mode, pressing this button can also disable/enable the heat function.

6. ROCKING

A program designed to relax the body by rocking the chair.

7. DEMO

This massage will quickly demonstrate all of the massage features in 5 minutes.

8. FOOT ROLLING

Foot Rolling Function Start/Stop Control Button

Press this button once to activate rhythmic rolling massage at soles, press this button again to stop rolling massage at soles.
Note: During Auto Program mode, pressing this button can also disable/enable the foot rolling function.

9. Z-G

Press this button in order to activate the zero gravity position.

10/11. CHAIR RECLINE AND RESTORE

Angle Adjustment Button for Leg Rest

Press and hold to comfortably lay flat or to restore the chair to its original position.

12. GENTLE

A program designed to provide a quiet, gentle massage that is good for beginners or those that prefer a soft touch.

13. NECK&SHOULDER

This massage will focus on your shoulders and neck using a combination of keading and shiatsu techniques.

14. RELAX

A program designed to provide a mild massage that is great for deep relaxation, best used before going to sleep.

15. VIGOROUS

This massage will combine vigorous tapping on your back and an air massage focused on your arms and legs.

16. LOWER BACK

This massage will focus on your lower back with a deep massage that includes air compression.

17. SPOT/PARTIAL

The Spot or Partial Back Massage

Press this button once to activate localized Spot Massage while the original massage mode continues to run at the latest position. Every single press on this button will change the massage function in the sequence of "SPOT > PARTIAL > STOP" in cycle.

Note: Partial Massage will use the latest Spot position as the center, and will travel approximately 10cm up or down. SPOT/PARTIAL button is only effective under manual massage mode.

18. WIDTH / LED LIGHT

The Width Adjustment Button / LED Lighting Button

Every single press on this button will change the massage width interval in the sequence of "Narrow > Medium >Wide" in cycle. When the on/off button is on, press and hold the Width button to turn on and off the LED light.

19/20. UPWARD/DOWNWARD ADJUSTMENT

When the spot and partial massage functions are activated, this button can be used to move the massage rollers. Hold this button to move the massage rollers upward/downward respectively. Release the buttons when you've reached the desired position.

21. MANUAL MASSAGE FUNCTION

KNEADING, TAPPING, KNEADING-TAPPING, CLAPPING, SWEDISH

Press this button to activate the rhythmic kneading manual massage function for a full back massage at medium strength. Every time this button is pressed, the manual massage function will change in the sequence of KNEADING>TAPPING>KNEADING-TAPPING>CLAPPING>SWEDISH>STOP.

22/23. SPEED

The Speed Adjustment Button

Every single press on this button will change the massage speed interval in the sequence of "Lv1 > Lv2 > Lv3 > Lv4 > Lv5" in cycle.

24. AIR BAG

Press this button to activate body air pressure massage from shoulder to soles. Every time this button is pressed, partial air massage function will change in the sequence of SHOULDER>ARM>CALF&FOOT>STOP.

25/26. AIR INTENSITY

The Intensity Adjustment button for air pressure massage has 5 levels of intensity.

When the air massage function is engaged, every single press on this button will change the air intensity in the sequence of "Lv1 > Lv2 > Lv3 > Lv4 > Lv5" in cycle.

SAFETY PRECAUTIONS

We're looking out for you.

IMPORTANT SAFETY INSTRUCTIONS

When using the massage chair, basic precautions should always be followed, including the following:

Read all instructions before using this massage chair.

DANGER - To reduce the risk of electric shock:

- Always unplug this massage chair from the electrical outlet immediately after using and before cleaning.
- Never use pins or other metallic fasteners with this appliance.
- Carefully examine the covering before each use. Call for service if the covering shows any sign of deterioration, such as blistering, peeling or cracking.
- Keep dry - do not operate in a wet or moist condition.

WARNING - To reduce the risks of burns, fire, electric shock or injury to persons:

- Read all instructions before using.
- A massage chair should never be left unattended when plugged in. Unplug from the outlet when it is not in use and before putting on or taking off parts.
- Close supervision is necessary when this massage chair is used by or near children or disabled persons. Keep children away from reclining backrest and extended leg rest.
- Use this massage chair only for its intended use as described in this manual.
- Never operate this massage chair if it has a damaged cord or plug, if it is not working properly, if it has been dropped or damaged, or dropped into water. Contact customer service department.
- Keep the cord away from heated surfaces.
- Never operate the massage chair with the air openings blocked. Keep the air openings free of lint, hair and the like.
- Never drop or insert any object into any opening.
- Do not use outdoors.
- Do not operate where aerosol (spray) products are being used or where oxygen is being administered.
- To disconnect, turn all controls to the off position, then remove the plug from the outlet.
- Do not stand on or in the massage chair. Use only while seated.
- The product is not intended for use by children or persons with reduced physical, sensory or mental capabilities, or lack of experience and knowledge, unless they have been given supervision or instruction concerning use of the product by a person responsible for their safety.
- Children should be supervised to ensure that they do not play with the product.
- Temperatures sufficiently high to cause burns may occur regardless of the control setting. Do not use on an infant or invalid or on a sleeping or unconscious person. Check the skin in contact with the heated area of the appliance frequently to reduce the risk of blistering.
- Burns may result from improper use.
- Do not crush in order to avoid sharp folds.
- Keep children away from extended foot support (or other similar parts).
- DO NOT WET.
- DO NOT USE PINS.
- NEVER REMOVE COVER.
- Connect this appliance to a properly grounded outlet only. See Grounding Instructions.

SAVE THESE INSTRUCTIONS

This massage chair is intended for household use only.

1. Usage Environment

- Do not use the massage chair in an excessively humid or dusty environment as this may result in malfunction or electric shock.
- Do not use the massage chair in a room with a temperature of 104°F or higher.
- Do not expose the massage chair to heaters, stoves or direct sunlight.
- Place and use the massage chair on an even, non-slip floor.
- The massage chair is designed for home use and not for commercial purposes.



Caution

- This massage chair is to be used indoors only.
- If you use the massage chair in a cold room, do not increase the room temperature abruptly. It is recommended that you increase the temperature gradually to a normal level.
- If the massage chair is stored in a cold place and is being brought into a warm environment, it is advisable to wait for one hour before use. This is because its performance may not be at an optimal level, as there may be water droplets on the mechanical parts due to condensation. Using the massage chair under such conditions may result in malfunction.

2. Safety Precautions

- To ensure safe and correct use of the massage chair, do not operate it without reading this operation manual carefully.
- Do not use the massage chair when the upholstery or seat is removed. This may cause injury or malfunction.
- Do not use the massage chair in combination with other therapeutic equipment or electric blanket etc., as this may result in ineffectiveness or injury.
- Do not use the massage chair an hour before or after eating as this may have adverse effects on the user.
- Do not allow children or pets to play around the massage chair, e.g. behind the backrest, under the seat base or legrest of the massage chair. This may result in injury.
- Do not use the massage chair when your body is wet.
- Do not operate the massage chair with wet hands.
- It is not recommended to use the massage chair for more than 30 minutes.
- Do not perform continuous massage on the same spot of your body for more than 5 minutes at a time as this may result in excessive stimulation and may have adverse effects.
- Do not insert your hand or foot along the paths of the massage rollers during use as this may cause injury.
- Stop operation immediately if you feel any discomfort.
- This product is not intended for self-treatment of conditions that should be managed by a qualified health care provider.
- People on medication or with medical conditions, please consult your doctor before use. Please do not use the product if you are not feeling well.

3. People with Medical Conditions

Consult your doctor before use if you:

- Are under medical rest as ordered by a doctor.
- Have spinal disorders, an abnormal spinal condition or have suffered a spinal injury.
- Have back problems.
- Have diabetes, osteoporosis or sensory impairment.
- Have joint dysfunction such as rheumatism, hammertoe or gout.
- Have a pacemaker or other electronic medical devices.
- May be pregnant.
- Have phlebitis or thrombosis.
- Have an increased risk for blood clots.
- Had recent surgery.
- Have surgical pins, screws, or anything mechanical in the legs, ankles or feet.



Caution

- This massage chair is not intended for use by children or persons with reduced physical, sensory or mental capabilities, or lack of experience and knowledge, unless they have been given supervision or instruction concerning use of the massage chair by a person responsible for their safety.
- Children should be supervised to ensure that they do not play with the massage chair.
- Avoid using the massage chair under the influence of alcohol.
- Do not apply massage rollers directly on the head, elbow or knee joints, torso or abdomen.
- If your legs or feet slip off the leg rest during massage, do not force them back in as this may result in injury.
- Remove the power plug from the electrical outlet immediately should liquid be accidentally spilled onto the massage chair. Do not use wet hands to connect or disconnect the power plug from the electrical outlet.
- Do not tamper with the power cord or use the massage chair with a damaged cord as this may result in malfunction and electric shock.

4. Instances When the Massage Chair Should Not Be Used

In the following events, please switch off the main power switch immediately and disconnect the power cord from the electrical outlet:

- If liquid is accidentally spilled onto the massage chair. This may result in electric shock or malfunction.
- If the fabric of the backrest is torn and the internal components are exposed.
- If pain or discomfort is felt during massage, stop operation immediately and consult your doctor.
- If you detect any malfunction or any other abnormal condition during operation.
- If there is power failure. Injury may occur when power is restored unexpectedly.
- If there is lightning.

5. Assembly and Repair of the Massage Chair

- Do not disassemble the backrest cover of the massage chair. Touching the internal components may result in malfunction or electrical shock.
- This massage chair must only be professionally serviced or repaired. Only disassemble or repair the massage chair if directed by a Cozzia service rep.

6. Things to Be Noted About the Power Plug and Cord

- Check that the Alternating Current (AC) voltage corresponds with the specifications indicated for the massage chair.
- Do not connect or disconnect the power plug from the electrical outlet with wet hands. This may result in malfunction or electric shock.
- When disconnecting the power plug, pull it by holding the plug, not the cord.
- Although operation will be stopped automatically by the Auto-Timer function, always remember to switch off the main power after use.
- Do not place the power cord under the massage chair or on any other heavy objects.
- Do not wind the power cord around the massage chair as this may damage the cord and result in a fire or electric shock.
- Do not operate the massage chair with a damaged cord or extension cord.
- Do not use the massage chair if the electrical outlet is loose.
- If the power cord is damaged, it should be replaced by a qualified technician.

GROUNDING INSTRUCTIONS

This product must be grounded. If it should malfunction or break down, grounding provides a path of least resistance for the electric current to reduce the risk of electric shock. This product is equipped with a cord that has an equipment-grounding conductor and a grounding plug. The plug must be plugged into an appropriate outlet that is properly installed and grounded in accordance with all local codes and ordinances.

Danger - Improper connection of the equipment-grounding conductor can result in a risk of electric shock. Check with a qualified electrician or service technician if it will not fit the outlet. Have a proper outlet installed by a qualified electrician.

This product is for use on a nominal 120V circuit and has a grounding plug that looks like that plug illustrated below. Make sure that the product is connected to an outlet having the same configuration as the plug. No adapter should be used with this product.

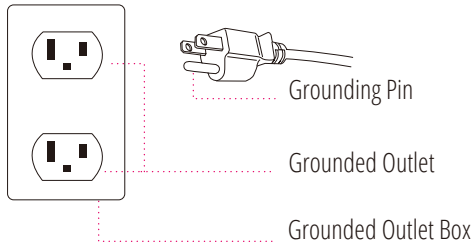

TROUBLESHOOTING

This massage chair is controlled by a microcomputer and is thus susceptible to power surges of +10 to - 15%. The following situations may arise in the event of a power surge:

Situation	Solution
The massage chair is connected to the power supply but is not functioning	<ol style="list-style-type: none">1. Check to see that the plug is properly connected and working2. Ensure the massage chair switch is in the 'I' position
The remote control works but the massage chair is not functioning	Possible overheating due to prolonged use. Turn off the power for at least 30 to 50 minutes
Both the remote control and the massage chair are not functioning	<ol style="list-style-type: none">1. Ensure the chair is plugged into a working outlet2. Turn the power OFF and ON again

If you continue to have problems, please read the warranty card and contact the Cozzia service department.

PRODUCT CARE AND STORAGE

1. Storing the Massage Chair

- Wipe off dust and dirt from the massage chair with a dry, soft, clean cloth after use.
- Keep the massage chair clean and away from places of high humidity.
- If the massage chair is not to be used for a long period of time, cover the massage chair with a dust cover and unplug its power plug from the electrical outlet.

Caution

- Do not store the massage chair in direct sunlight or in places of high temperature. This may cause the color of the upholstery to fade.
- Do not allow the massage chair to remain in contact with vinyl or wallpaper for extended periods of time as this could lead to discoloration.

2. Cleaning the Massage Chair

- Before cleaning, ensure that the main power switch is off and the power plug is disconnected from the electrical outlet.
- Wipe off dust and dirt from the massage with a dry, soft, clean cloth after each use.
- This product can be cleaned thoroughly with a slightly damp cloth.
- Do not iron the upholstery.
- Do not wash the upholstery using a home washing machine as this may result in deterioration of the upholstery's quality.

Caution

- Do not use abrasive cleaning agents like benzene or thinner to clean the massage chair. This may cause the upholstery to fade.

3. Cleaning the Controller

- Use only a clean, dry cloth to clean the controller.

Caution

- Do not use a wet cloth to clean the controller. This may result in malfunction.

COZZIA CONSUMER WARRANTY

Cozzia products have the following warranty:

The Cozzia massage chair Radiance has a one-year in home and parts service warranty. Cozzia customer service will not issue Return Material Authorizations (RMAs) for products. Cozzia products will be either repaired by the consumer or by an in-home technician. Cozzia will not issue Return Material Authorizations (RMAs) for buyer's remorse.

Service And Technical Support

Consumers may contact customer service department at 1-888-270-8538 between 8:00am- 4:00pm MST, Monday through Friday, email us at service@cozzia.ca, or visit our web at www.cozzia.ca for warranty or service issues.

Consumers are required to provide the unit serial number and dated proof of purchase (sales receipt) when they contact the Cozzia service department regarding a repair.

A Cozzia customer service representative will attend to most consumer inquiries, but in some cases a technical service specialist will provide advanced support.

Non-warranty repair is provided on a "per incident" basis. Cozzia customer service will verify that the unit has failed and provide instructions for repairing the unit. All applicable repairs, parts, shipping, handling, local tax and a "per incident" fee will be charged for non-warranty repairs and support calls.

Proof of purchase (original receipt) is required for all warranty repairs or service.

Extended Warranties:

Cozzia offers extended warranty programs to enhance the ownership of your massage chair. Please call Cozzia customer service at 888-270-8538 for details and pricing.

Product Repairs

- Floor Models and Demonstration Units have a prorated warranty period that begins the day the model is placed on the floor and connected to an electrical outlet by the retail partner. Proof of purchase is required in order to obtain warranty service and parts. Non-warranty parts and service are available at a “per incident” charge.
- Warranty Coverage Period - Warranty coverage starts at the time that the consumer PURCHASES their chair. Proof of purchase is required for all warranty repairs. The warranty time period is measured by continuous calendar days based on a seven-day week.
- Field Service - Cozzia customer service department will diagnose and schedule an authorized service provider to repair the chair in the consumer's residence.
- Parts - All parts deemed necessary for repairs will be shipped to the consumer at no charge by the Cozzia service department. Some Cozzia product repairs may be performed by the consumer in their own home with parts and instructions supplied by Cozzia, such as remote controller replacements that don't require a technician.

CONSUMER WARRANTY LIMITATIONS AND EXCLUSIONS

- Warranties are only valid in the 48 contiguous United States and Canada and are contingent upon the consumer operating the chair according to the corresponding instruction manual.
 - The warranty only applies to Cozzia products and does not include any accessories or enhancements.
 - Field service requires pre-approval and must be performed by Cozzia's authorized field service personnel.
 - Field service is only available in the United States and in major metropolitan areas in Canada.
 - Softening of foams and filling composites in pillows, pads, and memory foam occurs naturally and does not constitute a defect under this warranty.
 - Fading, wear and piling of fabrics occurs naturally and does not constitute a defect under this warranty.
 - Warranties do not cover any loss or damage resulting from improper installation, unauthorized repairs or modifications, improper use of electrical/power supply, loss of power, dropped product, a malfunction or damage of an operating part from failure to provide manufacturer's recommended maintenance, transportation damage, theft, abuse, misuse, neglect, vandalism or environmental conditions (fire, floods, rust, corrosion, sand, dirt, windstorm, hail, earthquake or exposure to weather conditions), loss of use during the period the product is at a repair facility, or otherwise awaiting parts or repair.
 - Under no circumstance shall Cozzia or its representatives be liable for indirect, consequential, or incidental damages (including damages for lost profits, business interruption, bodily injury, medical and the like), even if any party has been advised of the possibility of such damages.
 - Warranties are non-transferable.
 - Cozzia's sole liability and the purchaser's exclusive remedy shall be for the repair, or at Cozzia's option, for the replacement of the defective part.
 - Notwithstanding the above, if replacements parts for defective materials are not available, Cozzia reserves the right to make substitutions in lieu of repair or replacement.
-
- All warranties begin on the DATE OF PURCHASE; no allowance or extension is offered for delivery and/or installation.
 - Warranties do not apply to rental, business, commercial, institutional or other non-residential users.