



CZ-629^T User Manual

Welcome To **COZZIA**

Each COZZIA top 3D massage chair is equipped with a tablet, which replace the traditional buttons remote to operate the chair via Bluetooth built-in, let you enjoy the most advanced and easy massage experience. Meanwhile, the tablet also gives you much convenience for your business (supports Word, Excel, send & receive e-mails...) and entertainment (supports 3D game, chatting, movie playback, eBooks.....). For your easy using, before beginning, suggest reading the manual following.

COZZIAUSA.COM

Table Of Contents

Important Notices	01	Internet and Music	19-20
Keys and Functions	02-03	Camera and Gallery	21-22
Getting Started	04-06	Settings	23-24
COZZIA App	07-15	Troubleshooting	25-28
Network Connection	16-18		

IMPORTANT NOTICES

Please adjust the volume of the player to a moderate level and balance the using time while using the earphone to protect your hearing.

- Do not disconnect the tablet suddenly when formatting or uploading and downloading, which can lead to program errors.
- Do not dismantle the tablet by yourself, and do not use alcohol, thinners or benzene to clean its surface.
- The tablet does support USB charging. If you want to charge the tablet, it is preferred to use the supplied original power adaptor as USB charging speed is slower.
- Read this User Manual carefully. Make sure you know how to upgrade the tablet, otherwise do not upgrade it by yourself.

KEYS AND FUNCTIONS

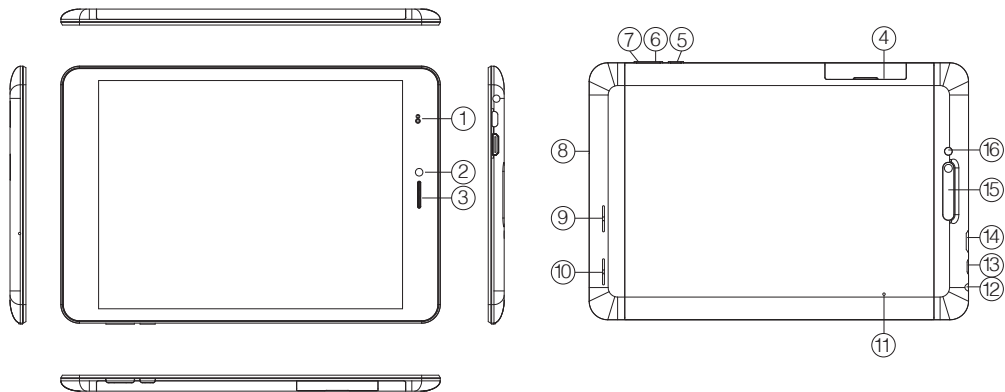

1.Distance Sensor	Distance sensor
2. Front camera	2M pixel front camera
3. Voice receiver	For receiving voice
4. Micro SD card slot(TF)	To insert your Micro SD card
5. Power and lock key	Hold and press to turn on or turn off the unit. Briefly press to turn on or turn off the screen.
6. Volume +	Press to increase voice
7. Volume -	Press to decrease voice
8. MIC	For recording voice
9/10. Speakers	Speakers
11. Reset	Tablet reset
12. Earphone Jack	To insert earphone
13. USB port	For connecting tablet and PC computer
14. HDMI Port	HDMI output
15. Rear camera	5M pixel rear camera.
16. Flash light	Flash while taking picture under dark condition

GETTING STARTED

3.1 Turn on/off

3.1.1 Turn on

To start your tablet, press and hold the power key at the right side of your tablet for a while. Tap and drag the lock out of the circle to unlock.

3.1.2 Turn off

To Power off your tablet, press and hold the power button until the dialogs appear and tap "Power off" and "OK".

3.1.3 Airplane Mode

Press and hold the power button until the dialog appears and tap "Airplane Mode".

3.2 Lock/unlock the screen

Put your tablet in sleep mode by turning off the LCD display to save battery. To do this, shortly press the power key. Press it again to wake up the screen.

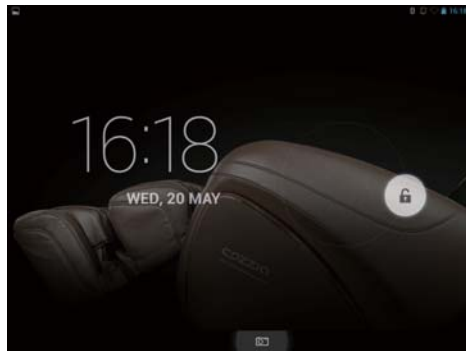
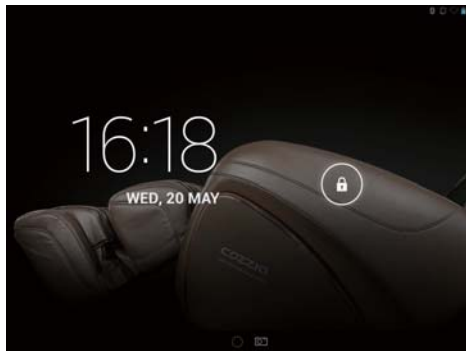

3.3 Sleep mode

The auto sleep time is preset at 5 minutes of inactivity. It can be adjusted in Setting-Display-Sleep.

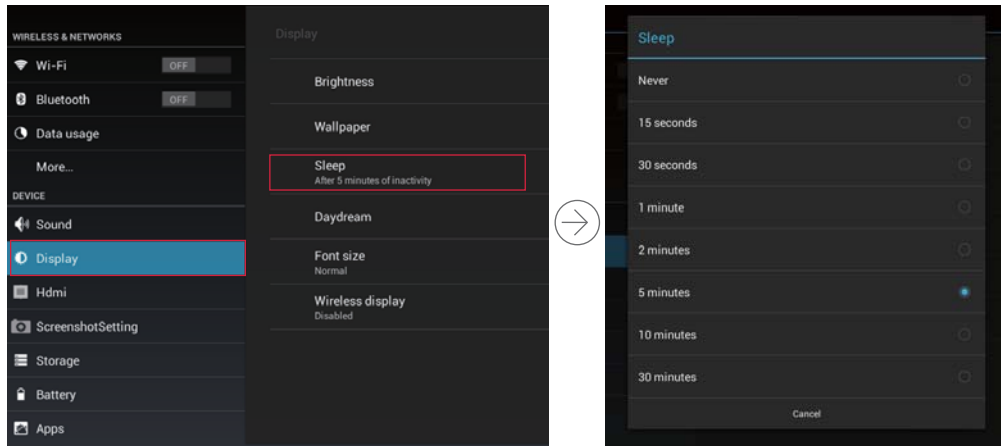

COZZIA APP

4.1 How to enter the COZZIA APP

4.1.1 Unlock the tablet, find out the COZZIA app  on the desktop and tap it.

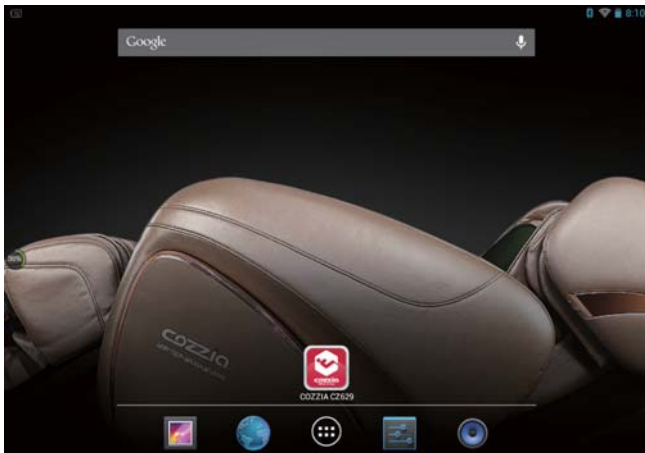

4.1.2 Press the COZZIA APP to enter into the main interface of the APP as below demonstrated. It includes three sections which are Home, Public and Service.

- Home is available only after register and log-in. It not only provides more various auto-programs in the “More” menu, but also allows each family member to create its own massage account and support each account to DIY its own customized program named “Exclusive VIP”.
- Public only provides quick and normal massage program without registering and log-in requirement.
- Service provides an access to guide the right and full functions of chair and app, as well as advises you how to seek for help when met problems.
- After accessing the “Public” or “Home”, it will guide you into the Bluetooth connecting page in setting. Please follow below Bluetooth connecting steps and attention to ensure the chair and tablet are well connected via Bluetooth. Then you will be able to enter and enjoy the massage program.



4.2 How to ensure the chair and tablet are well connected via Bluetooth.

Before using the COZZIA APP, it is required to connect the Bluetooth first. Please read below steps carefully.

Step 1: Insert the power plug and turn on the swift to "1" position on the rear bottom of chair base.

Step 2: Open "Setting-->Bluetooth" to search for the Massage Chair Bluetooth ID.

Step 3: Find and connect with the Massage Chair Bluetooth ID.

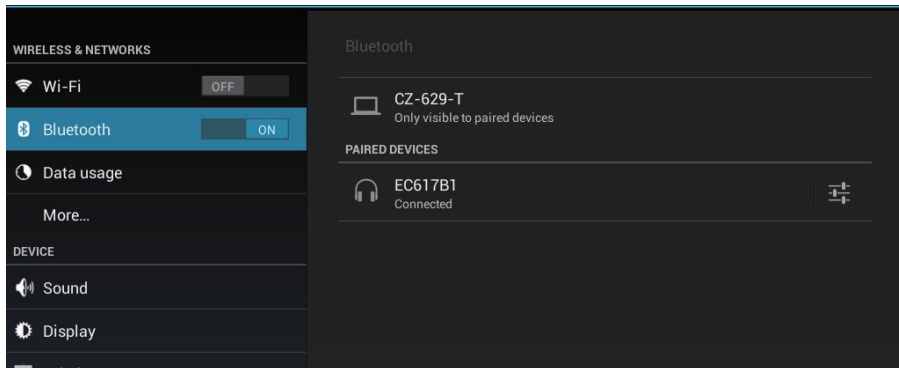

Step 4: The Bluetooth of the chair and tablet both can be occupied by one device at a time via Bluetooth.

* If the Bluetooth of the tablet has been connected to other device, un-pair it first, then try again.

* If the Bluetooth of the chair has been connected to other device, un-pair it first, then try again.

* If you have done the first two steps but the tablet still unable to connect with the Massage Chair, please contact local customer service department.

Step 5: If the Bluetooth dropped during operating the COZZIA APP, it will turn back to the connecting page to reconnect, and then you can renew the massage program by pressing the back icon.

Notes:

- Please be aware of avoid covering the Bluetooth signal spot which is around the power and lock key while holding and operating the tablet.



- Distance limit of Bluetooth connection

To guarantee the stability of the Bluetooth connection, the longest distance between the chair and tablet should be within 9ft while enjoying the massage or speaker music. And be aware that if the music out from head speaker sounded disturbing, it must be the Bluetooth connection not stable.

4.3 For more information about COZZIA Application, please refer to the app user guide in the pad.

4.4 Updating COZZIA APP

Step 1: Find the setting menu in the right corner of the Home page.



Step 2: Press it and a window will come out. Press "About" and then "Updates".

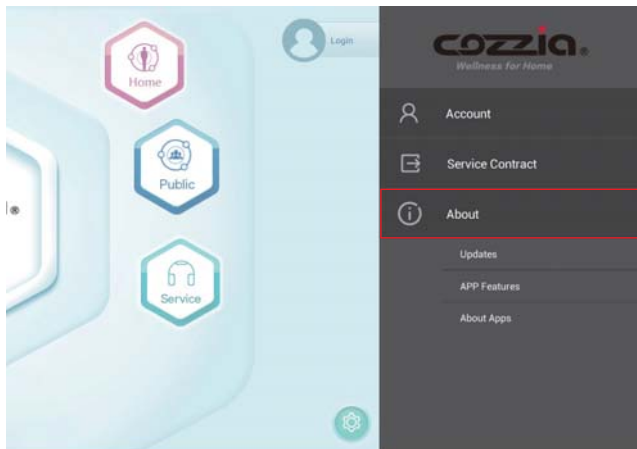

Step 3: Press “update” to update to the newest version.

Note: The APP updating works only when WI-FI is well connected.

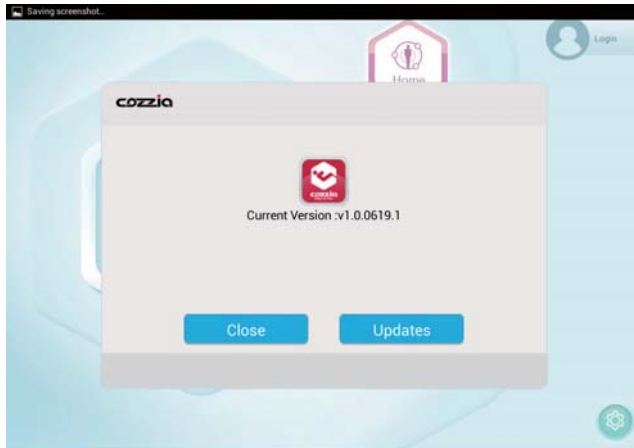

NETWORK CONNECTION

5.1 Wi-Fi

Wi-Fi can only be used when it connects with home Wi-Fi Access Point (AP) or a free unsecured Wi-Fi hotpot. Tap “Wi-Fi” to turn it on under “Wireless & Networks”. After a moment, your Wi-Fi networks list should populate. If you need to rescan for available networks, tap  on the upper right corner.

5.1.1 Turn on Wi-Fi

Within the App Panel, tap “Settings” → “Wi-Fi” to turn on the Wi-Fi.

Your tablet lists the networks it finds within range. Tap a network to connect. Enter password if necessary, and tap “Connect”. When your tablet is connected to the network, the wireless indicator appears in the status bar. Waves indicate connection strength.

5.1.2 Turn off Wi-Fi

Please turn off Wi-Fi if you’re not using to save the battery.If you want to turn on the Wi-Fi, please tap it again.

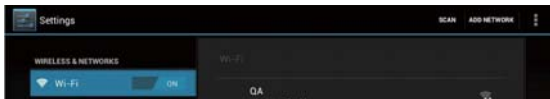

5.1.3 Add a Wi-Fi network

Users may also add a Wi-Fi network under “settings”. In “settings”, tap “+” on the upper right corner. Enter the SSID (name) of the network. If necessary, enter security or other network configuration details. Touch Save.

5.2 Bluetooth

5.2.1 Make device visible

You should pair your tablet with a device. Once you pair your tablet with a device successfully they stay paired unless you un-pair them.



Tap “Bluetooth” under “Settings”. Tap Bluetooth to turn it on and tap “Search for devices” on the upper right corner. Then the Bluetooth indicator appears in the status bar.

5.2.2 Scan for devices

After scanning, there will be a list of the IDs of all available Bluetooth devices in range. If you want to pair with the device, please make sure the device is turned on and set to be visible.

5.2.3 Pair with the Bluetooth device

Tap the name of an available Bluetooth device to pair with. Tap “pair” in the popup dialog “Bluetooth pairing request”. If the pairing is successful, your tablet connects to the device. Example: to transmit a photo.

Go to “Gallery”, choose a photo to share. Tap any spot on the photo to view a submenu. Tap icon  →  and then choose the device name in the paired devices list. The photo will then be sent. You can touch the right icon to un-pair the device.

Note:

After pairing, it shows under the Bluetooth device “Paired but not connected”, but file transmission is still possible. You can see the received files by touching the right corner icon. At present, the Bluetooth function only supports files transmission. To extend battery life, turn Bluetooth power off when not in use.

INTERNET AND MUSIC

6.1 Internet Browsing

Before using your browser, make sure Wi-Fi or internet is connected. In your app panel, tap the browser icon  to open your browser.

Tap the address bar, the Android keyboard will appear for your entry of keywords or URL.

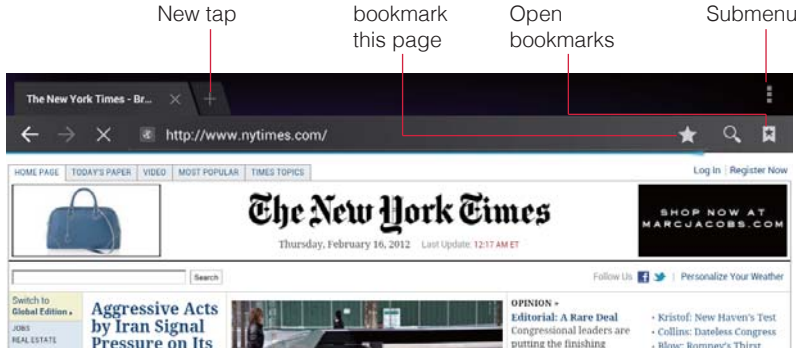

Tap the  icon in the top corner of the browser page to open the submenu.

6.2 Music

After loading your music into your tablet, tap the music icon  to open the music player. You can select songs by Artist, Albums, Songs or Play Lists.

The media player allows you to shuffle, skip, or pause your current selection and even displays the album artwork when available.

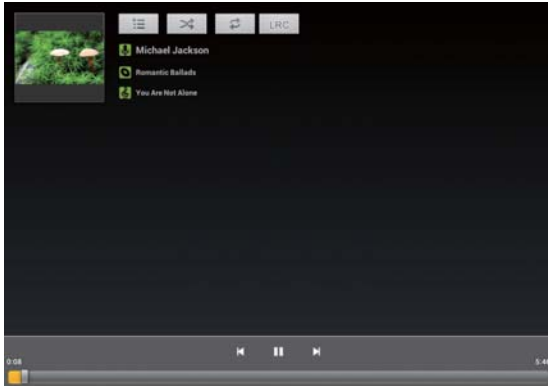

CAMERA AND GALLERY

7.1 Camera

Tap the  icon to open camera. Your tablet is built in 2M front camera and 5M rear camera. You can take a photo, or a video both by front camera and rear camera.

Note: After you power on your tablet, you can go to camera directly by dragging the lock to left.

Note: Auto Focus function, tap anywhere on the camera screen, the camera will focus on the spot you are tapping to. As the picture shows.

7.2 Gallery

You can view, show off, and even edit your digital pictures on the tablet's full color, high-resolution display. After loading your media, tap Gallery  to display your pictures.

Tap the picture you want to display, and slide right or left to show other pictures. Tap the menu icon, you can edit, rotate, crop, or set it as wallpaper.



SETTINGS

Tap the “Settings” icon to go to the settings. You can check and set wireless & networks, sound, display, storage, battery, accounts & sync, security, language, date & time, about tablet, etc.

- Wi-Fi: Tap “Settings” and “Wireless & Networks” to turn on Wi-Fi and scan. It will show a list of Wi-Fi networks scanned in range. Choose a strong Wi-Fi network to connect. (You may need to input the password).
- Bluetooth: turn on Bluetooth, enable the file transmission.
- Data usage: Tap “data usage” to monitor how much data tablet has been used.
- More: Tap “More” to check out more setting for the “Wireless Networks”.
- Sound: Turn on/off touch sound by tapping “Sound”—“Touch Sounds”.
- Display: To set Brightness, Wallpaper, Sleep, Daydream, Font size, Wireless display.
- HDMI: Tap “HDMI” can turn on/off the HDMI or tuning the HDMI resolution, etc.
- Screenshot Setting: Tap “Screenshot Setting”, press the option “how screenshot button on the status bar”, there will be a screenshot button on the bar.
- Storage: Check internal storage here. If you insert a TF card, or USB disk, you can check the total and available space for your TF card or USB disk. If you do not need extra space, please remove TF card of USB disk properly.
- Battery: Check the battery status here.
- Apps: Tap “apps” to monitor how many applications in the tablet and the remaining storage can be used.
- Location access: Tap location access to manually turn on/off the location sharing for the different application

such as if you need to use map, you need to turn on the location access first.

- Security: To set the pad lock by using pattern, pin or password, etc.
- Language & input: To set language and keyboard input.
- Backup & reset: To go to submenu "Back up my data" and "Factory data reset". If you choose factory data reset, all data from your tablet's internal storage will be erased. Choose this option carefully.
- Add account: If you like to have more service such as download different application, you can create a Google account in here.
- Date&time: In date&time, you can set the automatic time zone or manually set the time, also date format can be choosing in here.
- Accessibility: To turn on Talkback, Large text, Auto-rotated screen, etc.
- Developer Options: It is normally used by application or pad developer. Turn on the "Stay awake" to set the screen no to sleep while charging, etc.
- About Tablet: To check information about your tablet, such as model number, android version, etc.

TROUBLESHOOTING

1. Cannot turn on the tablet

Please charge the tablet if the power level is low before using. Reset it in case the tablet still cannot be turned on.

2. The tablet turn on with white screen, cannot enter the system

When the battery is low, the tablet cannot be turned on. Please charge it for half an hour and then restart it to enter the system.

3. Screen drift or unresponsive

Pin the reset button to reset your tablet and power it on again.

4. Tablet freezes, not response to touch anymore

Press the power button for a few seconds, or insert into the reset hole with some small stick.

5. The tablet cannot connect with the Massage Chair

- Open “setting Bluetooth” to check the Bluetooth is turned on.
- Search and pair with the massage chair Bluetooth ID.
- If the Bluetooth of the tablet has been connected to other device, un-pair it first, then try again.
- If the Bluetooth of the chair has been connected to other device, un-pair it first, then try again.

6. What if it got stuck and unresponsive while operating the COZZIA APP

Please try to turn off the app and re-start to enter.

7. What if I forgot my password to unlock the tablet.

You have to re-install the firmware.

8. Application not working

Possible reasons may be that this app is not compatible with your OS or the downloaded .apk file is broken so you may try to download it again.

9.How to install application properly?

- Connect the tablet to the PC or Mac.
- Copy the application to the tablet.
- Disconnect the tablet.
- Open the apk installer application in the menu.
- find the application and install it.
- After installing an application, you should open the application to make sure it could run correctly because some of the application cannot pair with tablet. That would occur system bug and if that situation occurs, delete the application and reinstall with a properly one.

10. How to create or delete application in the desktop

- Open the menu.
- Long press the application in the menu and drag to the rubbish bin on the upper screen.

11. How to mute the tablet

Long press the Volume – until it shows mute in the tablet.

12. What if no sound from earphone

Check if volume is set to '0'. Or earphone may be broken, please change for another one.

13. How to change the language

- open the setting.
- Press the "Language& input".
- press the "language" and choose the language in the open window.

14. Bluetooth cannot be turned in the setting by touching the ion

You can easily restart the tablet to solve this problem.

15. Cannot rotate the screen.

- Open settings.
- Type "Accessibility"
- Turn on the "Auto-rotate screen".

16. Cannot turn on Wi-Fi, or cannot access WIFI even though after inputting correct WIFI password

- Restart tablet.
- Check your Wi-Fi environment or restart your ADSL modem.

Note: If information above could not help you to solve problems, please reinstall the fire ware (fire ware upgrading procedures is in the application user guide of pad) or contact local customer service department.



14515 E Don Julian Rd, City of Industry, CA 91746

Tel: 1-877-977-0656

Fax: 1-800-521-4712

Email: service@cozziausa.com