

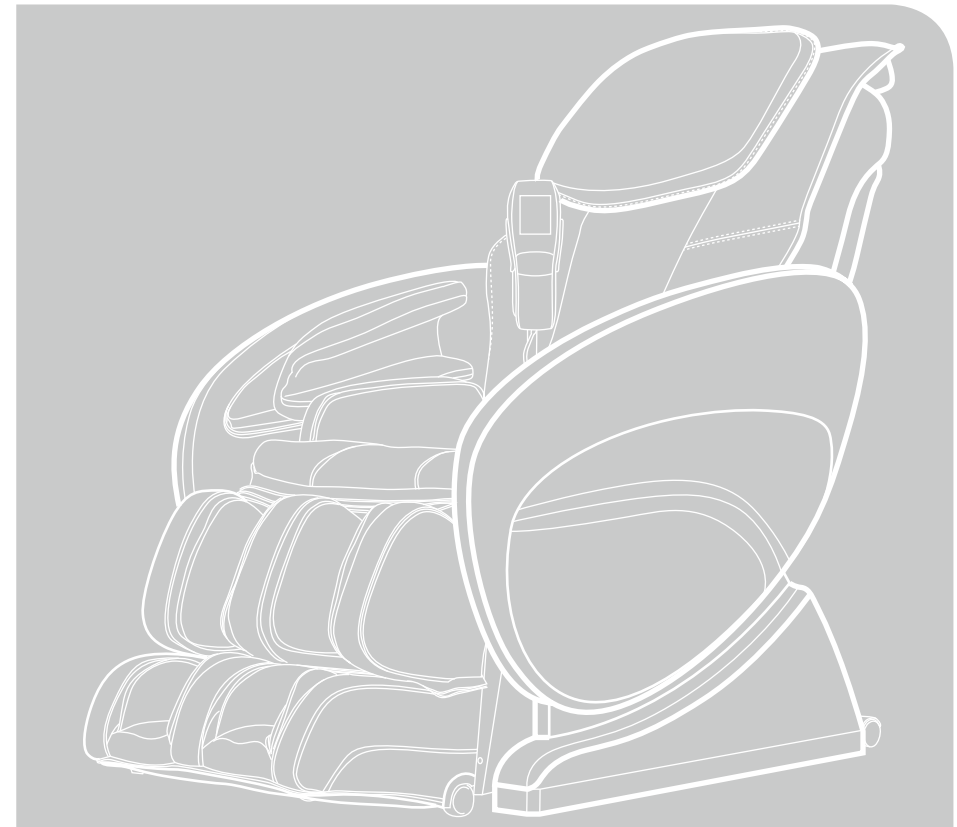

14515 E Don Julian Rd, City of Industry, CA 91746  
Tel: 1-877-977-0656  
Fax: 1-800-521-4712  
Email: [service@cozziausa.com](mailto:service@cozziausa.com)



**CZ-388**

Massage chair

Use & Care Manual

See more product update at:

[WWW.COZZIAUSA.COM](http://WWW.COZZIAUSA.COM)

See more product update at:

[WWW.COZZIAUSA.COM](http://WWW.COZZIAUSA.COM)

# Welcome To **COZZIA**

Thank you for purchasing the CZ-388 massage chair. Before using your chair, please take some time to read the contents of this instruction manual and for ease of enjoyment of this product, continue to use same as a reference guide.

[COZZIAUSA.COM](http://COZZIAUSA.COM)

## CZ-388

Massage chair

### TABLE OF CONTENTS

Luxury Features .....	01
Safety Precautions .....	02-06
Chair Components .....	07-08
Chair Specifications .....	09
Chair Installation & Moving .....	10-14
Operation Guides .....	15-21
Grounding Instructions .....	22
Troubleshooting .....	23
Product Care and Storage .....	24
Warranty Information .....	25-27
Warranty Card (Attachment)	

## LUXURY FEATURES

Operation of the CZ-388 massage chair is controlled by a microcomputer, enabling various intelligent massage functions, such as kneading, Swedish, tapping, shiatsu, clapping, rolling, Scrapping, vibration and air pressure twisting modes.

- Twin rollers to mimic the feel of the human thumb
- S-track backrest aligns with the curve of human spine to make the massage effective and comfortable;
- Auto scanning and finmanual adjustment to customize the height of back massage;
- The angle of backrest and legrest can be adjusted simultaneously and separately, backrest from 115 degree to 160 degree, while the Footrest from 0 degree to 90 degree, and ZGR position available by one-touch;
- 8 sets of Auto massage programs and various type of manual massage function are able to meet various requirement;
- Fully body air squeezing massage located in back, seat, arm and leg;
- Heating therapy for the lumbar region;
- Vibration function in the center of seat;
- Auto timing is adjustable to your desired duration of the massage;
- Liquid Crystal Display for a user friendly operation even in the dark;
- Designed with a power surge protector, automatic thermal sensor and auto shutdown for safety;
- Ergonomically designed to enhance massage experience.



## SAFETY PRECAUTIONS

### IMPORTANT SAFETY INSTRUCTIONS

When using the massage chair, basic precautions should always be followed, including the following:

Read all instructions before using this massage chair.

#### **DANGER**—To reduce the risk of electric shock:

- Always unplug this massage chair from the electrical outlet immediately after using and before cleaning.
- Never use pins or other metallic fasteners with this appliance.
- Carefully examine the covering before each use. Call for service if the covering shows any sign of deterioration, such as blistering, peeling or cracking.
- Keep dry—Do not operate in a wet or moist condition.

#### **WARNING**—To reduce the risks of burns, fire, electric shock or injury to persons:

- Read all instructions before using.
- A massage chair should never be left unattended when plugged in. Unplug from the outlet when it is not in use and before putting on or taking off parts.
- Close supervision is necessary when this massage chair is used by or near children or disabled persons. Keep children away from reclining backrest and extended leg rest.
- Use this massage chair only for its intended use as described in this manual.
- Never operate this massage chair if it has a damaged cord or plug, if it is not working properly, if it has been dropped or damaged, or dropped into water. Please contact the Customer Service Department.
- Keep the cord away from hot surfaces.
- Never operate the massage chair with the air openings blocked. Keep the air openings free of lint, hair and the like.
- Never drop or insert any object into any opening.
- Do not use outdoors.
- Do not operate where aerosol (spray) products are being used or where oxygen is being administered.

- To disconnect, turn all controls to the off position, then remove the plug from the outlet.
- Do not stand on or in the massage chair. Use only while seated.
- The product is not intended for use by children or persons with reduced physical, sensory or mental capabilities, or lack of experience and knowledge, unless they have been given supervision or instruction concerning use of the product by a person responsible for their safety.
- Children should be supervised to ensure that they do not play with the product.
- Temperatures sufficiently high to cause burns may occur regardless of the control setting. Do not use on an infant or invalid or on a sleeping or unconscious person. Check the skin in contact with the heated area of the appliance frequently to reduce the risk of blistering.
- Burns may result from improper use.
- Do not crush and avoid sharp folds.
- Keep children away from extended foot support (or other similar parts).
- DO NOT WET
- DO NOT USE PINS.
- NEVER REMOVE COVER.
- Connect this appliance to a properly grounded outlet only. See Grounding Instructions.

### SAVE THESE INSTRUCTIONS

This massage chair is intended for household use only.

#### 1.Usage Environment

- Do not use the massage chair in an excessively humid or dusty environment as this may result in malfunction or electric shock.
- Do not use the massage chair in a room with a temperature of 104° F (40° C) or higher.
- Do not expose the massage chair to heaters, stoves or direct sunlight.
- Place and use the massage chair on an even, non-slip floor.
- The massage chair is designed for home use and not for commercial purposes.



**Caution**

- This massage chair is to be used indoors only.
- If you use the massage chair in a cold room, do not increase the room temperature abruptly. It is recommended that you increase the temperature gradually to a normal level.
- If the massage chair is stored in a cold place and is being brought into a warm environment, it is advisable to wait for one hour before use. This is because its performance may not be at optimum level, as there may be water droplets on the mechanical parts due to condensation. Using the massage chair under such conditions may result in malfunction.

**2.Safety Precautions**

- To ensure safe and correct use of the massage chair, do not operate it without reading this operation manual carefully.
- Do not use the massage chair when the upholstery or seat is removed. This may cause injury or malfunction.
- Do not use the massage chair in combination with other therapeutic equipment or electric blanket etc., as this may result in ineffectiveness or injury.
- Do not use the massage chair an hour before or after eating as this may have adverse effects on the user.
- Do not allow children or pets to play around the massage chair, e.g. behind the backrest, under the seat or leg rest of the massage chair. This may result in injury.
- Do not use the massage chair when your body is wet.
- Do not operate the massage chair with wet hands.
- It is not recommended to use the massage chair for more than 15 minutes.
- Do not perform continuous massage on the same sport of your body for more than 5 minutes at a time as this may result in excessive stimulation and may have adverse effects.
- Do not insert your hand or foot along the paths of the massage rollers during use as this may cause injury.
- Stop operation immediately if you experience any discomfort.
- This product is not intended for self-treatment of conditions that should be managed by a qualified health care provider.
- People on medication or with medical conditions should consult their doctor before use. Please do not use the product if you are not feeling well.

**3.People with Medical Conditions**

- are under medical rest as ordered by a doctor.
- have spinal disorders, an abnormal spinal condition or have suffered a spinal injury.
- have back problems.
- have diabetes, osteoporosis or sensory impairment.
- have joint dysfunction such as rheumatism, hammertoe or gout.
- have a pacemaker or other electronic medical devices.
- may be pregnant.
- have phlebitis or thrombosis.
- have an increased risk for blood clots.
- had recent surgery.
- Have surgical pins, screws, or anything mechanical in the legs, ankles or feet.



**Caution**

- This massage chair is not intended for use by children or persons with reduced physical, sensory or mental capabilities, or lack of experience and knowledge, unless they have been given supervision or instruction or instruction concerning use of the massage chair by a person responsible for their safety.
- Children should be supervised to ensure that they do not play with the massage chair.
- Avoid using the massage chair under the influence of alcohol.
- Do not apply massage rollers directly on the head, elbow or knee joints, torso or abdomen.
- If your legs or feet slip off the leg rest during massage, do not force them back in as this may result in injury.
- Remove the power plug from the electrical outlet immediately should liquid be accidentally spilled onto the massage chair. Do not use wet hands to connect or disconnect the power plug from the electrical outlet.
- Do not tamper with the power cord or use the massage with a damaged cord as this may result in malfunction and electric shock.

#### 4. Instances When the Massage Chair Should Not Be Used

In the following events, please switch off the main power switch immediately and disconnect the power cord from the electrical outlet:

- If water is accidentally spilled onto the massage chair. This may result in electric shock or malfunction.
- If the fabric of the backrest is torn and the internal components are exposed.
- If pain or discomfort is felt during massage, stop operation immediately and consult your doctor.
- If you detect any malfunction or any other abnormal condition during operation.
- If there is power failure. Injury may occur when power is restored unexpectedly.
- If there is lightning.

#### 5. Assembly and Repair of the Massage Chair

- Do not disassemble the backrest cover of the massage chair. Touching the internal components may result in malfunction or electrical shock.
- This massage chair must only be professionally serviced or repaired. Do not attempt to disassemble or repair the massage chair by yourself.

#### 6. Things to Be Noted About the Power Plug and Cord

- Check that the Alternating Current (AC) voltage corresponds with the specifications indicated for the massage chair.
- Do not connect or disconnect the power plug from the electrical outlet with wet hands. This may result in malfunction or electric shock.
- When disconnecting the power plug, pull it by holding the plug, not the cord.
- Although operation will be stopped automatically by the Auto-Timer function, always remember to switch off the main power after use.
- Do not place the power cord under the massage chair or any other heavy objects.
- Do not wind the power cord around the massage chair as this may damage the cord and result in a fire or electric shock.
- Do not operate the massage with a damaged cord or extension cord.
- Do not use the massage if the electrical outlet is loose.
- If the power cord is damaged, it should be replaced by a qualified technician.

## CHAIR COMPONENTS

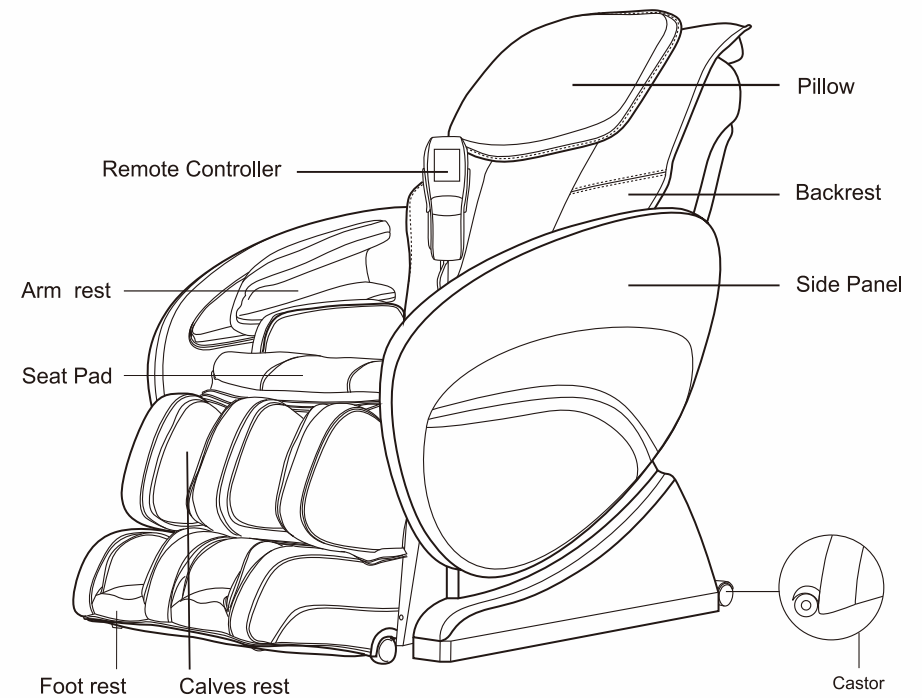

## Massaging position

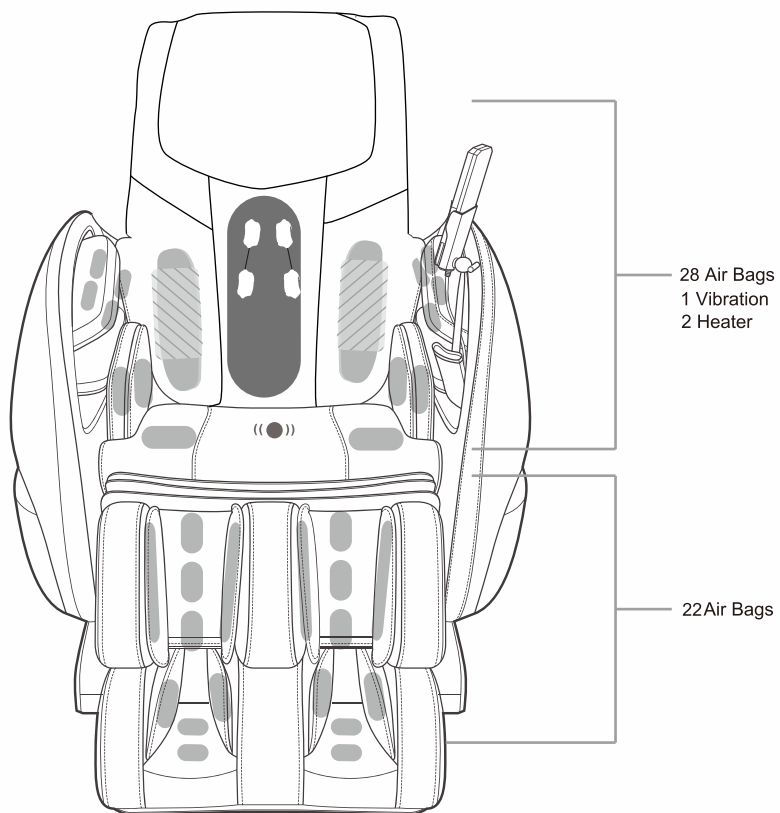

## CHAIR SPECIFICATIONS

Description	Specifications	
Model No.	CZ-388	
Rated Voltage	110-120V	
Rated Frequency	60Hz	
Rated Power Consumption	240W	
Timer	5/10/15/20/25/30 minutes	
Max. Time rate	30 minutes	
Dimensions (LxWxH)	Chair Upright: 56" x 35" x 47.3"	
	Chair reclined: 69.7" x 35" x 38.2"	
	Seat carton: 53.3" x 30.9" x 38.4"	
	Side panels carton: 38.1" x 25" x 14.6"	
Weight	Net Weight:	Seat Part: 191.8 lbs Side Panel: 44lbs
	Gross Weight:	Seat Part: 240.2 lbs Side Panel: 48.5 lbs
Length of wiring	Controller wiring 31.5"	
	Power supply wiring 70.9"	
	Music connection wiring: 6"	
Usage condition	Environmental temperature 10°C-40°C Contrasting humidity level 30-85RH	
Storage condition	Storage temperature 20°C-60°C Storage humidity level 30-85RH	
Safety feature	Equipped with overheating and power surge detectors	
Using benefits	Increasing blood circulation, relieving muscular fatigue	

Back Massage Mode    
 Air Bag    
 Vibration    
 Heater

## CHAIR INSTALLATION & MOVING



- Initially confirm that the alternating current (AC) corresponds with the specifications indicated for the massage chair;
- Allow for a minimum of 24 inches free space between any wall or furniture and both the front and the back of the chair, with the backrest reclined and the foot rest extended fully;
- DO NOT connect to power when installing the chair.

### Step 1. Assembling side panel

- 1.1 Unpack the chair base and side panel;
- 1.2 Connect the air tube out from the side panel and seat frame as demonstrated in PIC.1;
- 1.3 Insert the side panel along the hook to the holder (on the chair base frame), at 90 degrees as demonstrated in PIC.2;
- Note:** Please be careful to avoid scratching during installation;
- 1.4 Adjust the side panel to make the screw holes well aligned, then fix the side panel to the seat by using accompanying spacer, washer and bolts, as demonstrated in PIC.3;
- 1.5 Repeat above step 1.2–1.4 to install the other side panel;

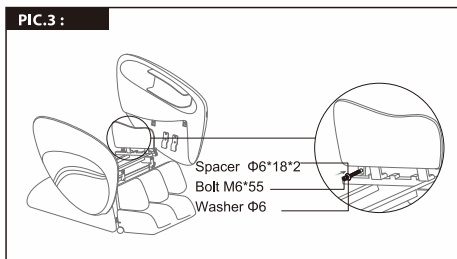
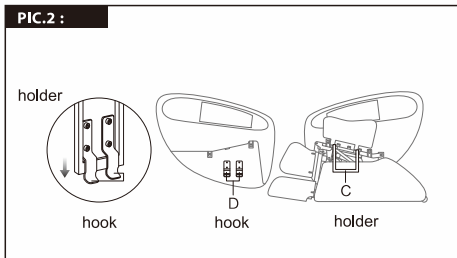
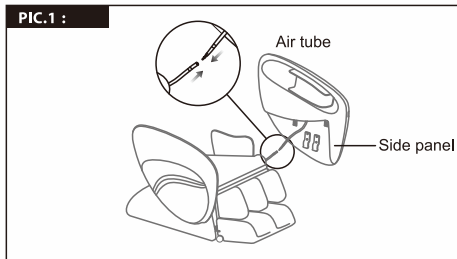

### Step 2. Assembling the controller holder

- Put the controller holder onto the ball-shape bracket, and lock the screws as demonstrated in PIC.4, then you could place the remote controller into the holder.

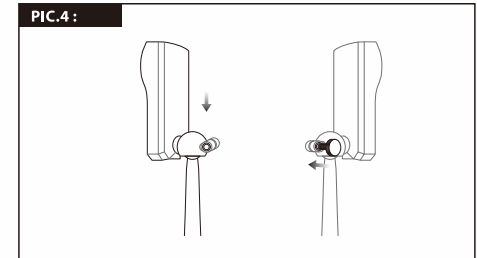

### Step 3. Assembling the backrest part

- 3.1 Use the diagonal pliers to cut the cable tie, which binds the stopper of the backrest actuator, and take off the packing material as PIC.5;
- 3.2 Lift and insert the backrest into the seat frame, by securely locking the flat head bolts A into holder B, as demonstrated in PIC.6;

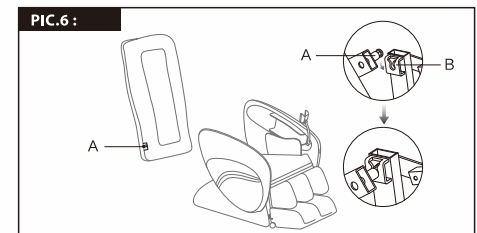
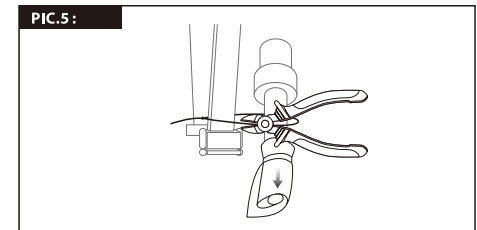

- A. Flat head bolt (on the backrest)
- B. Holder (on the seat frame)

- 3.3 Attach the backrest connection rod (marked C in the PIC.7) to the U stay fork (marked D in the PIC.7) with the flat head rivet (marked E in the PIC.7), and secure with the split pin (marked F in the PIC.7);

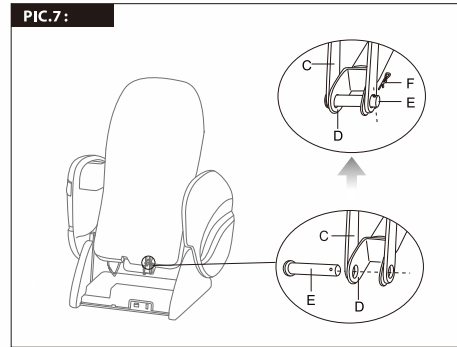

- 3.4 Connect the plugs to the corresponding place in the seat according to the marks given, as demonstrated in PIC.8;

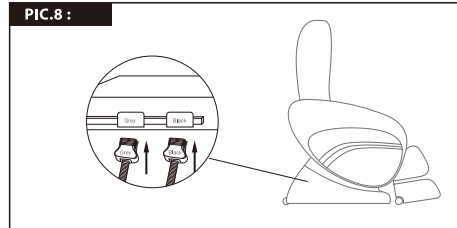

- 3.5 Attach the backrest pad and pillow by zipping in place and then align the velcro padding onto the backrest;

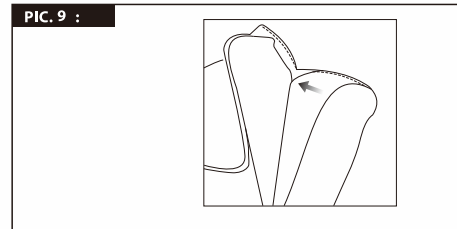

**Note:** The back massage strength control pad is inserted into the back seat cover and can be removed if desired to strengthen the massage function and replaced to lessen the strength of the massage function.

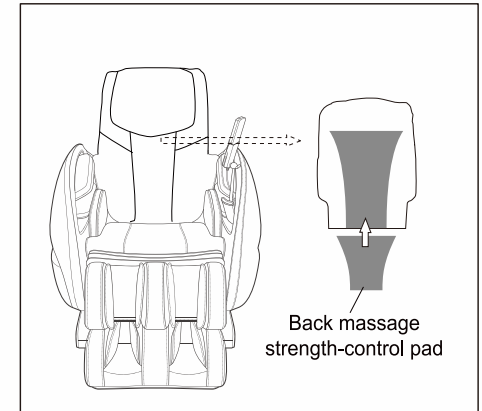

**Step 4. Connect the power cord to the rear of the chair.**

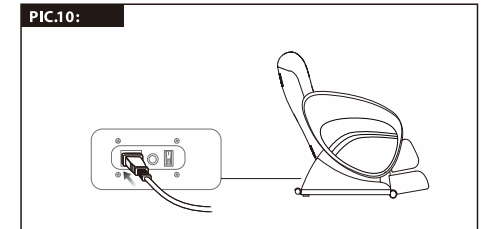

**Note:** Once assembly has been completed and you are intending to use the chair, please fully insert the chair's power plug into a properly fitted electrical outlet. No adapters should be used when connecting this product to the power source. Improper grounding may result in electrical shock. If you are not sure whether or not the product is properly grounded, do not attempt any modifications yourself, but contact a qualified electrician.



## MOVING THE CHAIR

1. Restore the footrest to its original position.
2. Recline the chair to tilt approximately 45 degrees. Move the chair using the wheels as the fulcrum.

**Note:**

- Always return the footrest to its original length and restore it to its original position before moving the chair, otherwise injury during movement may result.
- Do not move the chair while a person is seated on it.
- Place a mat on the floor and gently roll the chair over it to avoid damaging the floor.

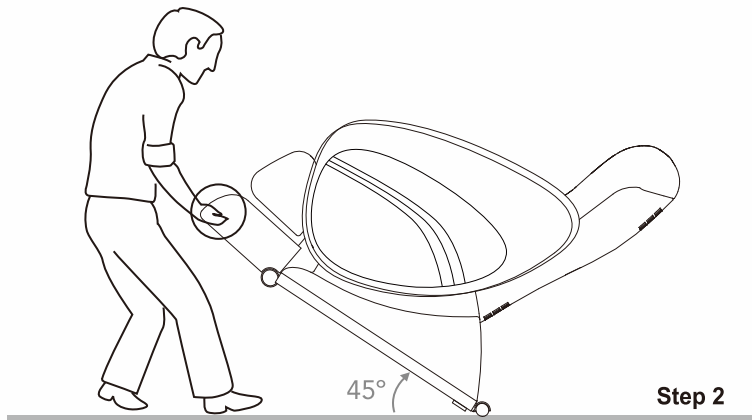
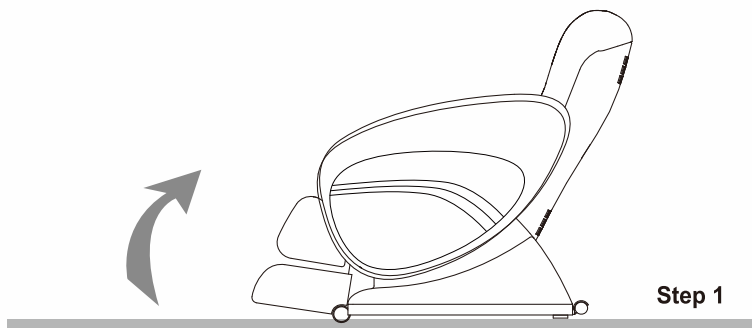

## OPERATION GUIDES

Once connected to a power outlet, switch the power supply button under the chair to the '1' position and then use the remote control to enjoy massage.

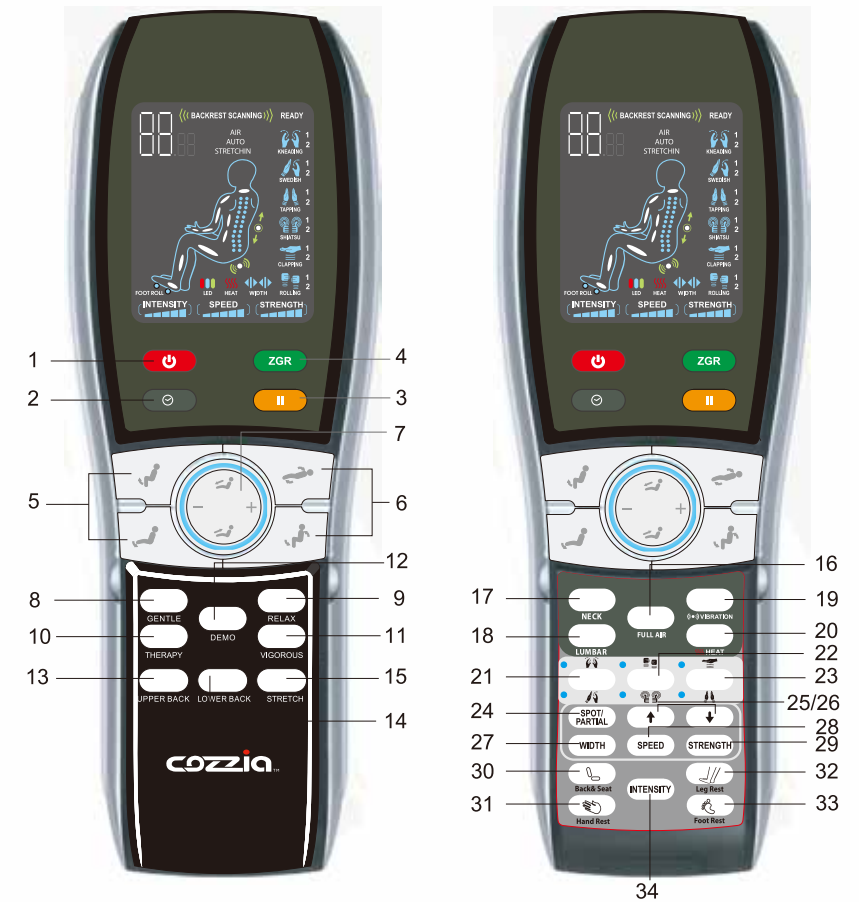

## Control Buttons for the CZ-388

### 1. ON/OFF



The start/ stop control button.

Press once to light ON the LCD screen, which indicate that the chair is in idle mode. Any massage function can then be pressed, also starting the timer. Press the ON/OFF button to stop all massage functions.

### 2. TIMER



Once a massage function is activated the chair will automatically set to a 15 minute massage mode. To change the timing duration, press the timing button which will display in sequence a massage timing mode of 20mins–25mins–30mins–5 mins–10mins–15mins. Cease pressing the timing button once the desired timing is shown. When one minute of the desired timing remains, 5 beeps will be sounded to alert the user.

### 3. THE PAUSE BUTTON



When the chair is in massage mode and you want to temporarily stop the massage function, press the pause button. The pause icon will blink on the liquid crystal display. The timer will also automatically pause. The massage chair is now in idle mode and only the ON/OFF, LEG REST RECLINE/RESTORE, CHAIR RECLINE/RESTORE and PAUSE functions can be used. In order to cease the pause function, press the pause button again and the original massage function will resume.

### 4. ZGR



Press this button to activate the ZGR function and press again to stop the ZGR massage position.

**Note:** The ZGR button will not respond during the Swedish and Thai full body auto massage programs.

### 5. LEG REST RECLINE AND RESTORE



The angle adjustment buttons for the leg rest. Press and release either button until the leg rest reaches your desired position.



### 6. CHAIR RECLINE AND RESTORE



The angle adjustment buttons for the chair position. Press and release to recline back, and to restore to the original position.

### 7. LEGREST LENGTH ADJUSTMENT BUTTON

These two control buttons can adjust the length of the legrest.

Press  or  once to lengthen or shorten the chair legrest, and press again to confirm the comfortable position you want.

#### Notes:

1. Please press the button softly to avoid sticking the button;
2. The 1st time ZGR program is activated after chair is turn on, the chair will scan and adjust the leg rest length automatically, and will remember the customized leg rest length for you.

## Eight full body auto programs as follows:

### 8. GENTLE

### 9. RELAX

### 10. THERAPY

### 11. VIGOROUS

### 12. DEMO

Press this button for a brief demonstration of the overall features of the CZ-388 massage chair

### 13. UPPER BACK

### 14. LOWER BACK

### 15. STRETCH



**Notes:**

Once one of the eight full body auto programs (and also demonstration) is activated by pressing the corresponding button, the CZ-388 massage chair will automatically enact a height scan for the back. Press the button again to stop the program.

**16. FULL AIR**

The auto full body air function start/stop control button.. Press this button to activate a fully body air pressure massage from neck to soles. Press the button again to cease the function.

**17. Neck**

The spot massage function located at neck start/stop control button. Press this button to activate a spot relief massage at the neck zone. Press the button again to cease the function.

**18. LUMBAR**

The spot massage function located at lumbar start/stop control button. Press this button to activate a spot relief massage at the lumbar zone. Press the button again to cease the function.

**19. VIBRATION** 

The seat vibration start/ stop control button. Press this button to activate the seat vibration mode. Press the button again to cease the function.

**Note:**

During any auto massage program pressing this button can disable the seat vibration function and pressing the button again will recommence the action.

**20. HEAT** 

The lumbar heat function start/ stop control button. Press this button to activate the lumbar heat function. Press this button again to cease the function.

**Note:**

during any auto massage program, pressing this button will disable the lumbar heat function, and pressing the button again will resumethe function.

**Specialized Programs**

**21. KNEADING** 

The kneading mode start/ stop control button. Press once to activate a full kneading back massage at medium strength. Press this button again to activate a reversed mode of kneading action. Press the button for the third time to stop the kneading function and switch to the Swedish style function.

**21. SWEDISH** 

The Swedish style start/ stop control button. When mode 2 kneading action is engaged, press this button to activate a Swedish style full back massage function at medium speed. Press the button again for a second speed Swedish style massage and press the button again to cease the function. To access the Swedish style massage function directly, press this button three times when the massage chair is in idle mode.

**22. TAPPING** 

The tapping function start/ stop control button. Press this button to activate the tapping style full back massage at medium speed. Press the button again for a second speed tapping style massage. Press the button for a third time to cease the tapping function and switch to the Shiatsu function.times when the massage chair is in idle mode.

**22. SHIATSU** 

The Shiatsu function start/ stop control button. When mode 2 tapping action is engaged action is engaged, press this button to activate the Shiatsu style full back massage at medium speed. Press the button again for a second speed Shiatsu style massage. Press the button for a third time to cease the Shiatsu function. To access the Shiatsu style massage function directly, press this button three times when the massage chair is in the idle mode.

**23. CLAPPING:** 

The clapping function start/ stop control button. Press this button to activate a clapping full back massage at medium speed. Press the button again for a second speed clapping style massage. Press the button for a third time to stop the clapping function and switch to the rolling function.



### 23. ROLLING

The rolling function start/ stop control button. When mode 2 clapping action is engaged, press this button to activate a rolling style full back massage. Press the button again to stop the rolling function. To activate the rolling function directly, press the button three times when the massage chair is in the idle mode.

**Note:** this function cannot be used for a spot massage.

### 24. SPOT/PARTIAL

The spot and partial function start/ stop control button. Press this button to activate a localized spot massage while the original massage mode continues to run. Press this button again to switch to the partial massage function.

Note: the partial massage function will perform a partial massage ranging to a width of 3.14 inches from the central massaging position.

### 25 and 26. UPWARD/DOWNWARD

The position adjustment buttons for spot or partial massage. These buttons are used to adjust the backrest massage position for spot or partial massage. Hold the upwards or downwards button to move the massage rollers upwards or downwards respectively until the ideal position is obtained, then release the button to continue the spot or partial massage function.

### 27. WIDTH

This button is for width adjustment to the tapping, clapping, shiatsu and rolling functions, each having three width levels, narrow, medium and wide. When activating any one of these programs, press this button to adjust the width of the motion to target the desired area.

### 28. SPEED

This button is for speed adjustment to the tapping, clapping, shiatsu and Swedish style functions. When activating any one of these programs, press this button to adjust the speed of the motion ranging through five levels from low to high. (1 to 5).

### 29. STRENGTH

This button is for strength adjustment to the kneading function. When activating the kneading mode, press this button to adjust the strength of the action ranging through five levels from low to high. (1 to 5).

## Localized Air Pressure Programs

### 30. BACK and SEAT

The back and seat air pressure start/ stop control button. Press this button to activate the air massage located in the back and seat. Press the button again to stop the function.

### 31. HAND REST

The hand air pressure start/ stop control button. Press this button to activate the air pressure massage for arms and hands. Press the button again to stop the function.

### 32. LEG REST

The leg air pressure start/stop control button. Press this button to activate the air massage for legs. Press the button again to stop the function.

### 33. FOOT REST

The foot rest air pressure start/ stop control button. Press this button to activate an air pressure massage in the foot rest. Press this button again to stop the function.

### 34. AIR INTENSITY

The intensity adjustment button for air pressure functions.

After activating an air pressure function press this button to adjust the intensity through five levels, ranging from low to high. (1 to 5 in cycle).

To finish operating and return the massage rollers to the original position, press the ON/OFF button and then switch the power supply button to the 'O' position and then unplug the machine from the power source.

## GROUNDING INSTRUCTIONS

This product must be grounded. If it should malfunction or break down, grounding provides a path of least resistance for the electric current to reduce the risk of electric shock. This product is equipped with a cord with an equipment-grounding conductor and a grounding plug. The plug must be plugged into an appropriate outlet that is properly installed and grounded in accordance with all local codes and ordinances.

Danger—Improper connection of the equipment-grounding conductor can result in a risk of electric shock. Check with a qualified electrician or service technician if you provided with the product—if it will not fit the outlet, have a proper outlet installed by a qualified electrician.

This product is for use on a nominal 120V circuit and has grounding plug that looks like that plug illustrated below. Make sure that the product is connected to an outlet having the same configuration as the plug. No adapter should be used with this product.

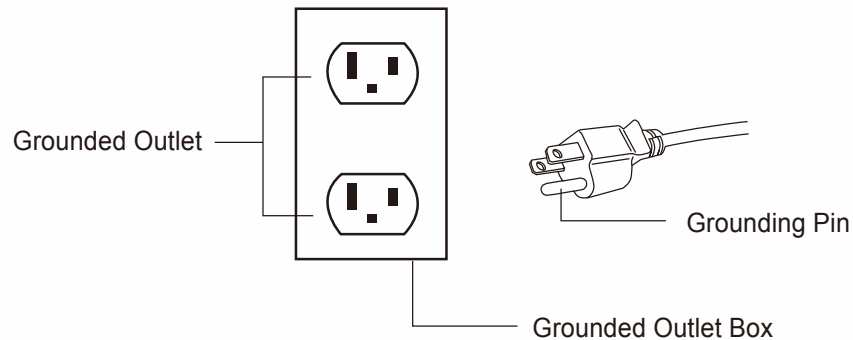

## TROUBLESHOOTING

This massage chair is controlled by a microcomputer and is thus susceptible to power surges of +10 to-15%. The following situations may arise in the event of a power surge:

Situation	Solution
The massage chair is connected to the power supply but is not functioning	<ol style="list-style-type: none"> <li>1. Check to see that the plug is properly connected and working</li> <li>2. Ensure the massage chair switch is in the 'I' position</li> </ol>
The remote control works but the massage chair is not functioning	Possible overheating due to prolonged use. Turn off the power for at least 30 to 50 minutes
Both the remote control and the massage chair are not functioning	<ol style="list-style-type: none"> <li>1. Ensure the chair is plugged into a working outlet</li> <li>2. Turn the power OFF and ON again</li> </ol>

Should you continue to have problems, please refer to the warranty and contact the CozziaService Department.



## PRODUCT CARE AND STORAGE

### 1. Storing the Massage Chair

- Wipe off dust and dirt from the massage chair with a dry, soft, clean cloth after use.
- Keep the massage chair clean and away from places with high humidity.
- If the massage is not to be used for a long period of time, cover the massage chair with a dust cover and unplug its power plug from the electrical outlet.

#### Caution

- Do not store the massage chair in direct sunlight or in places of high temperature. This may cause the color of the upholstery to fade.
- Do not allow the massage chair to remain in contact with vinyl or wallpaper for extended periods of time as this could lead to discoloration.

### 2. Cleaning the Massage Chair

- Before cleaning, ensure that the main power switch is off and the power plug is disconnected from the electrical outlet.
- Wipe off dust and dirt from the massage with a dry, soft, clean cloth after each use.
- This product can be cleaned thoroughly with a slightly damp cloth.
- Do not iron the upholstery.
- Do not wash the upholstery using a home washing machine as this may result in deterioration of the upholstery's quality.

#### Caution

- Do not use abrasive cleaning agents like benzene or thinner to clean the massage chair. This may cause the upholstery to fade.

### 3. Cleaning the Controller

- Use only a clean, dry cloth to clean the controller.

#### Caution

- Do not use a wet cloth to clean the controller. This may result in malfunction.

## WARRANTY INFORMATION

### Cozzia products have the following warranty:

COZZIA's massage chairs, motion upholstery and home theater massage seating provide a ONE YEAR in home servicing warranty and a TWO YEAR parts warranty.

COZZIA customer service will not issue Return Material Authorizations (RMAs) for products. COZZIA products will be repaired by the consumer or by an in home technician. COZZIA will not issue Return Material Authorizations (RMA's) to buyers.

### SERVICE AND TECHNICAL SUPPORT

Consumers may contact COZZIA's customer service department at 1-877-977-0656 between 9.00am and 5.00pm PST, Monday through Friday or email us at [Service@cozziausa.com](mailto:Service@cozziausa.com) or visit our web site at [www.cozziausa.com](http://www.cozziausa.com) for warranty and service issues.

Consumers are required to provide the unit serial number and dated proof of purchase (sales receipt) when they contact the COZZIA Service Department regarding repair.

A COZZIA customer service representative will attend to most consumer inquiries but in some cases a technical service specialist will be required to provide enhanced support.

Non-warranty repair is provided on a 'per incident' basis. COZZIA customer service will verify that the unit has failed and provide instructions for repair. All applicable repairs, parts, shipping, handling, local tax and a 'per incident' fee will be charged for non-warranty repairs and support calls.

Proof of purchase (original receipt) is required for all warranty repairs or servicing.

### EXTENDED WARRANTIES

COZZIA offers extended warranty programs to enhance ownership of COZZIA products.

Extended warranty provides a three year limited repair or replacement massage chair warranty with on-site service.

Please visit [www.cozziausa.com](http://www.cozziausa.com) for the latest terms and pricing for extended warranties.

Many COZZIA product repairs may be performed by the consumer in his/her own home with



parts and instructions supplied by COZZIA such as remote controller replacement that does not require the service of a technician.

- Floor Models and Demonstration Units: have a pro-rated warranty period that begins the day the model is placed on the floor and connected to an electrical outlet by the retail partner. Proof of purchase is required in order to obtain warranty service and parts. Non-warranty parts and service are available at a 'per incident' charge.
- Warranty Coverage Period: warranty coverage starts at the time the consumer purchases their chair. Proof of purchase is required for all warranty repairs. The warranty time period is measured by continuous calendar days based on the seven day week.
- Field Service: COZZIA customer service department will diagnose and schedule an authorized service provider to repair the chair in the consumer's residence
- Parts: all parts deemed necessary for repairs will be shipped to the consumer at no charge by the COZZIA service department.

### CONSUMER WARRANTY LIMITATIONS AND EXCLUSIONS

- Warranties are only valid in the 48 contiguous United States and Canada and are contingent upon the consumer operating the chair according to the corresponding instruction manual.
- The warranty only applies to COZZIA products and does not include any accessories or enhancements.
- Field service requires pre-approval and must be performed by COZZIA's authorized field service personnel. Field service is only available in the 48 contiguous United States.
- Softening of foam and filling composites in pillows, pads and memory foam occurs naturally and does not constitute a defect under this warranty
- Fading, wear and piling of fabric occurs naturally and does not constitute a defect under this warranty
- Natural markings, grain and dye variations in leather do not constitute a defect under this warranty
- Warranties do not cover any loss or damage resulting from improper installation, unauthorized repairs or modifications, improper use of the electrical/power supply, loss of power, a dropped product, a malfunction or damage of an operating part from failure to implement the manufacturer's recommended maintenance, transportation damage, theft, abuse, misuse, neglect, vandalism or environmental conditions (fire, floods, rust, corrosion, sand, dirt, windstorm, hail, earthquake or exposure to weather conditions), loss of use during

the period the product is at a repair facility or is otherwise awaiting parts or repair

- Damage due to shipping and handling does not constitute a defect under this warranty
  - Under no circumstances shall COZZIA or its representatives be liable for indirect consequential or incidental damages (including damages for lost profits, business interruption, bodily injury, medical problems) even if the other party has been advised of the possibility of such damages or possible problems
  - Warranties are non-transferable and shall be in lieu of any other warranty express or implied, including but not limited to any implied warranty or merchantability or fitness for particular use
  - COZZIA's sole liability and the purchaser's exclusive remedy shall be for repair, or at COZZIA's option, for the replacement of the defective part. Notwithstanding the above, if replacement parts for defective materials are not available, COZZIA reserves the right to make substitutions in lieu of repair or replacement.
- All warranties begin on the DATE OF PURCHASE; no allowance or extension is offered for delivery and/or installation.**
- Warranties do not apply to rental, business, commercial, institutional or other non-residential users.**



## WARRANTY REGISTRATION FORM

Product Serial No. (located on product) \_\_\_\_\_

Purchase price \_\_\_\_\_ Model No. \_\_\_\_\_

First Name \_\_\_\_\_ Last Name \_\_\_\_\_

Address \_\_\_\_\_

City \_\_\_\_\_ State \_\_\_\_\_ Zip \_\_\_\_\_

Phone \_\_\_\_\_

Email \_\_\_\_\_

Please mail to:

COZZIA USA LLC

14515 E Don Julian Rd

City of Industry CA 91746

Tel: 1-877-977-0656

Fax: 1-800-521-4712