



14515 E Don Julian Rd, City of Industry, CA 91746  
Tel: 1-877-977-0656  
Fax: 1-800-521-4712  
Email: [service@cozzia-usa.com](mailto:service@cozzia-usa.com)



**AC510**

Ergonomic Seating

Use & Care Manual

See more product update at:

[WWW.COZZIAUSA.COM](http://WWW.COZZIAUSA.COM)

See more product update at:

[WWW.COZZIAUSA.COM](http://WWW.COZZIAUSA.COM)

# Welcome To **COZZIA**

Thank you for purchasing the AC510 ergonomic Seating. Before using your chair, please read the contents of this instruction manual and refer to it when needed.

[COZZIAUSA.COM](http://COZZIAUSA.COM)

## AC510

Massage chair

### TABLE OF CONTENTS

















Assembly Instructions - - - - - 1-6

Operation Instructions - - - - - 7-10

Warranty Information - - - - - 11

Warranty Card( Attachment)

### ASSEMBLY INSTRUCTIONS

Part#	Description	Quantity	Picture
1	Pre-assembled Seat Cushion, Mechanism and Wood Base	1	
2	Back Cushion	1	
3	Arms	2	
4	Ottoman Cushion	1	
5	Ottoman Central Post	1	
6	Ottoman Wood Base	1	
7	1" Big Screws	2	
8	Nuts	2	
9	3" Long Screws	2	
10	3/4" Small Screws	4	
11	1-3/4" Long Screws	3	
12	Spring Washers	3	
13	Flat Washers	3	
14	Wrenches	1	
		1	
15	Power Adapter with Power Cord	1	
		1	

- Read the assembly instructions thoroughly and assemble the recliner per the assembly instructions.
- Please note that using an incorrect assembly method may damage the structure of the recliner!
- Please note that the air pressure or heating massage function will stop automatically after 15mins as the auto timer is 15 mins.

**STEP 1:**

Place the pre-assembled Seat Cushion, Mechanism and Wood Base (1) on a protected surface to avoid scratching while assembling. Attach Arms (3A & 3B) to the Seat Cushion (1) by sliding the pre-attached metal brackets at the sides of the Arms (3A & 3B) into the pre-attached metal brackets on the Seat Cushion (1). Press down firmly on each arm until fully engaged.

**TWO PEOPLE ARE RECOMMENDED FOR BACK CUSHION ASSEMBLY!**

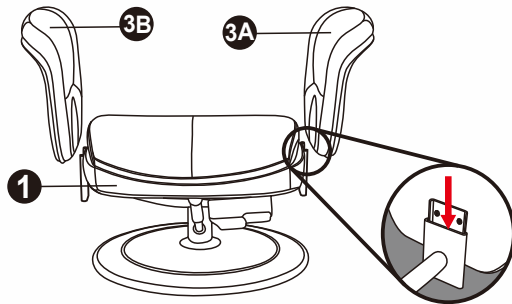

**STEP 2:**

Lift and place the Back Cushion (2) on the Seat Cushion (1), then open the zipper located on the Back Cushion (2) and align the holes on the Back Cushion (2) with the holes on the Arms (3A & 3B) and attach by using the 3" Long Screws (9). After tightening the screws, close the zipper.

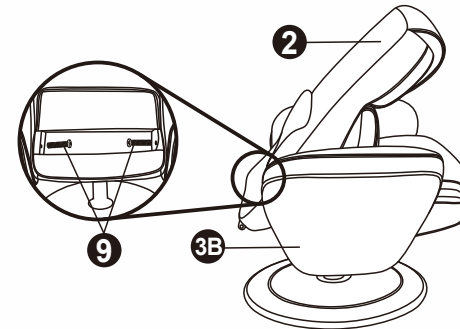

**STEP 3:**

After assembling the Back Cushion (2) to the Arms (3A & 3B), push the Back Cushion (2) backwards and slide the Seat Cushion (1) to the front for easy assembly. Align the holes of each bracket on the bottom of the Back Cushion (2) to the metal rings on the rear of the Seat Cushion (1). Insert the 1" Big Screws (7) through the metal rings in the Nuts (8) and tighten the screws. If the holes do not align easily, ensure from Step 1 that arms are pushed down firmly and fully engaged.

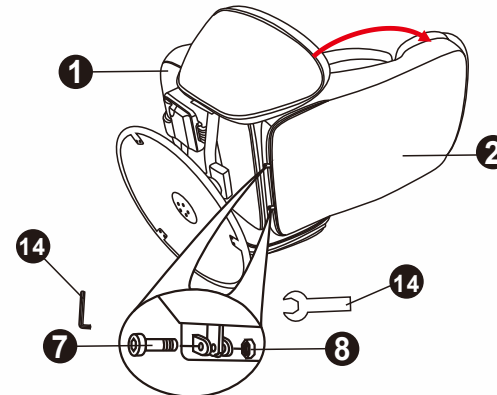

**STEP 4:**

Open the safety catch of the cable under the right arm and connect the two ports of the cable together. Then secure the safety catch on.

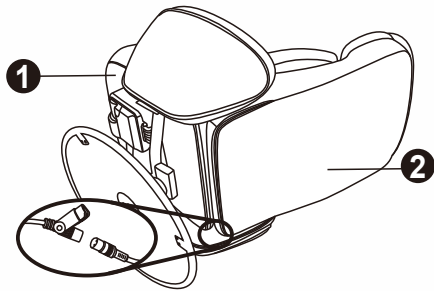

**STEP 5:**

Connect the ports of the Heating Cord (A) and Air Pipe (B) plugs separately on the Back Cushion (2) into the corresponding ports on the Seat Cushion(1).

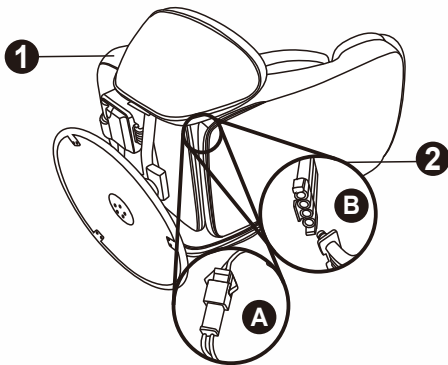

**STEP 6:**

**NOTE:** Remove the Packing Material (C) placed between the back cushion and the air frame.

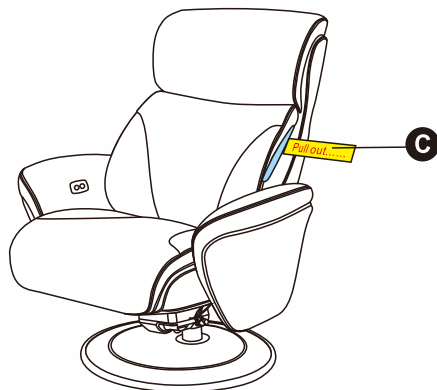

**STEP 7:**

Turn the Ottoman Cushion (4) upside down on the floor and attach the Ottoman Central Post (5) to the Ottoman Cushion (4) by using 3/4" Small Screws (10). Align the Ottoman Central Post (5) so the FRONT on the Ottoman Central Post (5) matches the FRONT label on the bottom of the Ottoman (4). Tighten the screws.

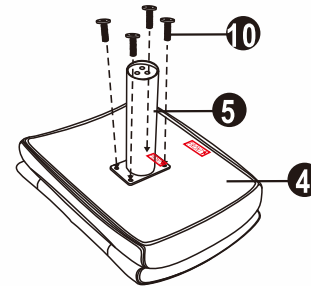

**STEP 8:**

Attach the Ottoman Wood Base (6) on top of the Ottoman Central Post (5). Fasten by using 1-3/4" Long Screws (11) with Spring Washers (12) and Flat Washers (13). Tighten all screws.

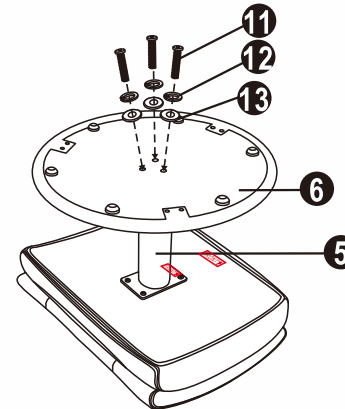



## OPERATING INSTRUCTIONS

### STEP 9:

Turn the ottoman upright.

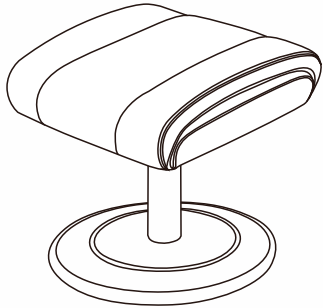

### 1. To tilt the recliner:

While seated, push the back cushion to recline so it will move backwards. To return the back cushion to the original position, apply more weight onto the seat cushion.



### 2. To adjust headrest angle:

Hold the headrest and push it to the desired angle.



### STEP 10:

1. Take out the power adapter and power cord, connect the power adapter and the power cord .
2. Plug the port of the power adapter into the power cord port of the recliner.
3. Make sure all the cables are firmly connected then plug the power cord to the socket-outlet(110V-240V).

**NOTE:** The socket-outlet shall be installed near the equipment and shall be easily accessible.

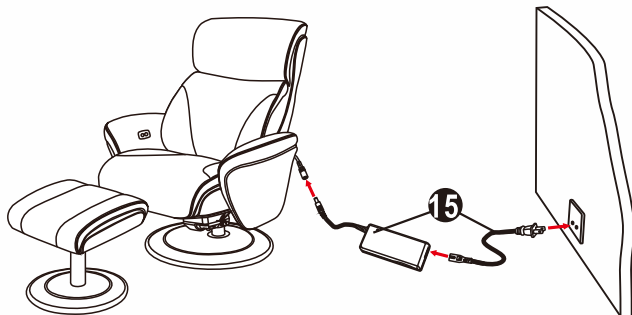



**3. 270 degree swivel:**

While seated in the recliner, enjoy the 270 degree swivel feature as shown.

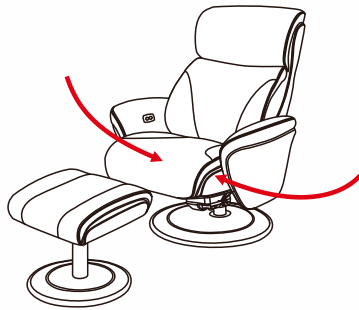

**5. Turn on/off the heating power button:**

Press and release the heating power button located on the right side of the arm to turn on/off the heating operating system, the indicator lights will be on/off. The heating system can effectively relieve the fatigue of your lumbar and promote the blood circulation to maximize your all-day working comfort.

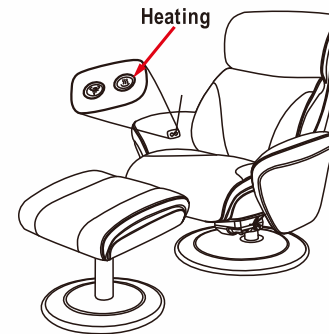

**4. Turn on/off the air cell massage power button:**

Press and release the massage power button located on the right side of the arm to turn on/off the massage operating system, the indicator lights will be on/off. Air cell massage using principle of air pressure massage, with the change of the flow and pressure of the air, perfectly fit human body posture and give your lumbar a better support to relieve your back pain and make a new comfortable seat.

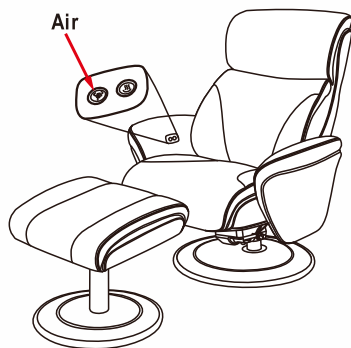

**6. About the breathability of the air lumbar cushion:**

While seated, the open-air contours of the cushion which is designed to breathe and flex, can dynamically provide continuous support by connecting with your body's natural movement. The air cushion conforms to the curve of your spinal cord and is intended to relieve your back from stress.

\*Note: It is not intended to diagnose, treat, cure or prevent any disease. If pain increases, please discontinue use.



### 7. About the neutral posture of the air lumbar cushion:

The Air™ chair has been shown to help the user achieve Neutral Posture. Neutral Posture has been shown to reduce back strain and increase long term seated comfort.

\*Provides constant support as you lean back and twist

\*Flexible lumbar pivots and conforms following your movement

\*Continuous proper lumbar support help keep the body in an optimal working position for maximum comfort

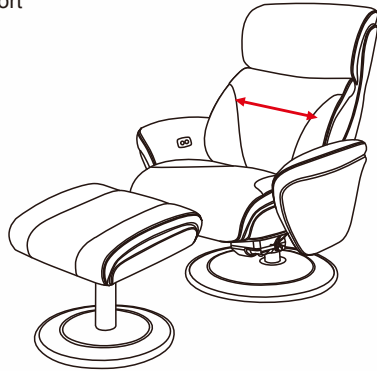

#### Warning:

1. Please carefully read and assemble this recliner per the instructions. Failure to follow the assembly instructions may cause danger.
2. Do not connect the power cord to the outlet prior to connecting the plug of the power adapter to the cables of the recliner.
3. In order not to damage the power adapter and cables, do not overrotate the recliner while charging.
4. Please remove and put away the power adapter when not used.

## WARRANTY INFORMATION

### COZZIA products have the following warranty:

COZZIA ergonomic seating products provide a one year in-home service warranty and a two-year parts warranty. COZZIA customer service will not issue Return Material Authorizations (RMAs) for products. COZZIA products will be either repaired by the consumer or by an in-home technician.

### Service and Technical Support

Consumers may contact COZZIA's customer service department at 1-877-977-0656 between 9:00 am and 5:00 pm PST, Monday through Friday or email us at [service@cozziausa.com](mailto:service@cozziausa.com) for warranty or service issues.

Consumers are required to provide the unit serial number and dated proof of purchase (sales receipt) when they contact the COZZIA service department regarding a repair.

A COZZIA customer service representative will attend to most consumer inquiries, but in some cases a technical service specialist will provide advanced support.

Non-warranty repair is provided on a "per incident" basis. COZZIA customer service will verify that the unit has failed and provide instructions for repairing a unit. All applicable repairs, parts, shipping, handling, local tax and a "per incident" fee will be charged for non-warranty repairs and support calls.

Proof of purchase (original receipt) is required for all warranty repairs or service.

### CONSUMER WARRANTY LIMITATIONS AND EXCLUSIONS

- Softening of foams and filling composites in pillows, pads, and memory foam occurs naturally and does not constitute a defect under this warranty.
- Natural markings such as scars, brands, grain variations, wrinkles, color variations, etc. will be considered normal characteristics and not construed as defects. We cannot warrant leather against scratching or scuffing, as all leather is subject to blemishes with use.
- Warranties are non-transferable and shall be in lieu of any other warranty, express or implied, including but not limited to any implied warranty or merchantability or fitness for particular use.
- All warranties begin on the DATE OF PURCHASE; no allowance or extension is offered for delivery and/or installation.
- Warranties do not apply to rental, business, commercial, institutional or other non-residential users.



## WARRANTY REGISTRATION FORM

Product Serial No. (located on product) \_\_\_\_\_

Model No. \_\_\_\_\_

Purchase Price \_\_\_\_\_ Place of Purchase \_\_\_\_\_

First Name \_\_\_\_\_ Last Name \_\_\_\_\_

Address \_\_\_\_\_

City \_\_\_\_\_ State \_\_\_\_\_ Zip \_\_\_\_\_

Phone \_\_\_\_\_

Email \_\_\_\_\_

Please mail to:

COZZIA USA LLC

14515 E Don Julian Rd

City of Industry CA 91746

Tel: 1-877-977-0656

Fax: 1-800-521-4712